

**WCN-541NW1-110N-45K****SPECIFICATION**

| WCN                 |                        |   | CUSTOMER<br>Confirmed |
|---------------------|------------------------|---|-----------------------|
| Prepared by         | Checked by             | Approved by   |                       |
| LiuGuo<br>2018-11-9 | ZhangChun<br>2018-11-9 |  |                       |



ATTENTION  
OBSERVE PRECAUTIONS  
FOR HANDLING  
ELECTROSTATIC  
SENSITIVE DEVICES



## Selection Guide

| Part No.            | Dice         |               | Lens Color  | Iv(mcd)(If=20mA) |     |      | Viewing angle<br>(2θ1/2) |
|---------------------|--------------|---------------|-------------|------------------|-----|------|--------------------------|
|                     | Raw Material | Emitted Color |             | Min              | Typ | Max  |                          |
| WCN-541NW1-110N-45K | InGaN        | Natural White | Water Clear | 1100             | --- | 3200 | 110°                     |

## Package Outline

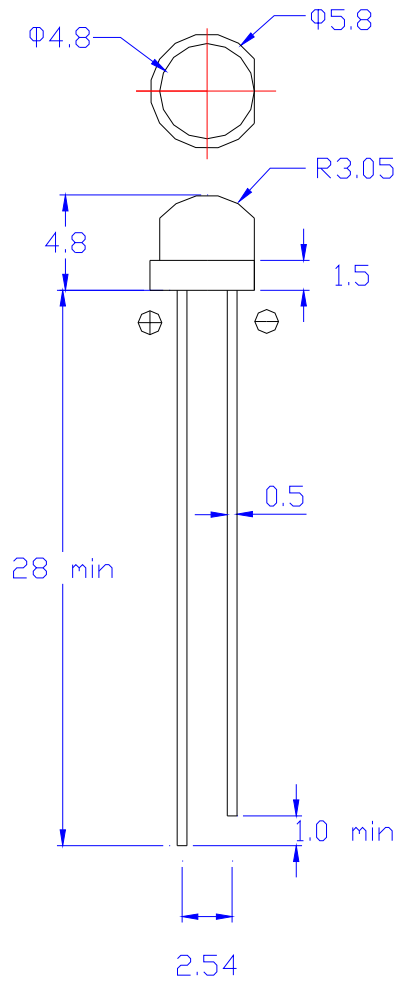

### NOTES:

1. All dimensions units are millimeters ;
2. All dimensions tolerances are  $\pm 0.2\text{mm}$  unless otherwise noted.

## Absolute Maximum Ratings at Ta=25°C

| Parameter               | Symbol | Rating    | Units |
|-------------------------|--------|-----------|-------|
| Power Dissipation       | Pd     | 68        | mW    |
| Forward current         | IF     | 20        | mA    |
| Peak Forward Current    | IFP    | 100       | mA    |
| Reverse voltage         | VR     | 5         | V     |
| Electrostatic Discharge | ESD    | 1000      | V     |
| Operating temperature   | Topr   | -30~+85   | °C    |
| Storage temperature     | Tstg   | -40 ~+100 | °C    |

## Electrical/Optical characteristics at Ta=25°C

| Item                         | test condition | Symbol | Value |      |      | Unit |
|------------------------------|----------------|--------|-------|------|------|------|
|                              |                |        | Min.  | Typ. | Max. |      |
| Forward voltage              | If=20mA        | Vf     | 2.8   | --   | 3.0  | V    |
|                              |                |        | 3.0   | --   | 3.2  | V    |
|                              |                |        | 3.2   | --   | 3.4  | V    |
| Luminous intensity           | If=20mA        | Iv     | 1100  | --   | 1400 | mcd  |
|                              |                |        | 1400  | --   | 1800 | mcd  |
|                              |                |        | 1800  | --   | 2400 | mcd  |
|                              |                |        | 2400  | --   | 3200 | mcd  |
| Correlated Color Temperature | If=20mA        | CCT    | 4600  | --   | 5000 | K    |
| Reverse current              | Vr=5V          | Ir     | --    | --   | 10   | μA   |
| Viewing angle at 50% Iv      | If=20mA        | 2 θ1/2 | --    | 110  | --   | Deg  |

**NOTE:**

- 1.1/10 Duty cycle, 0.1ms pulse width.
2. The above forward voltage measurement allowance tolerance is 0.1V.
3. the above luminous intensity measurement allowance tolerance ±10%.

**Chromaticity Bin**

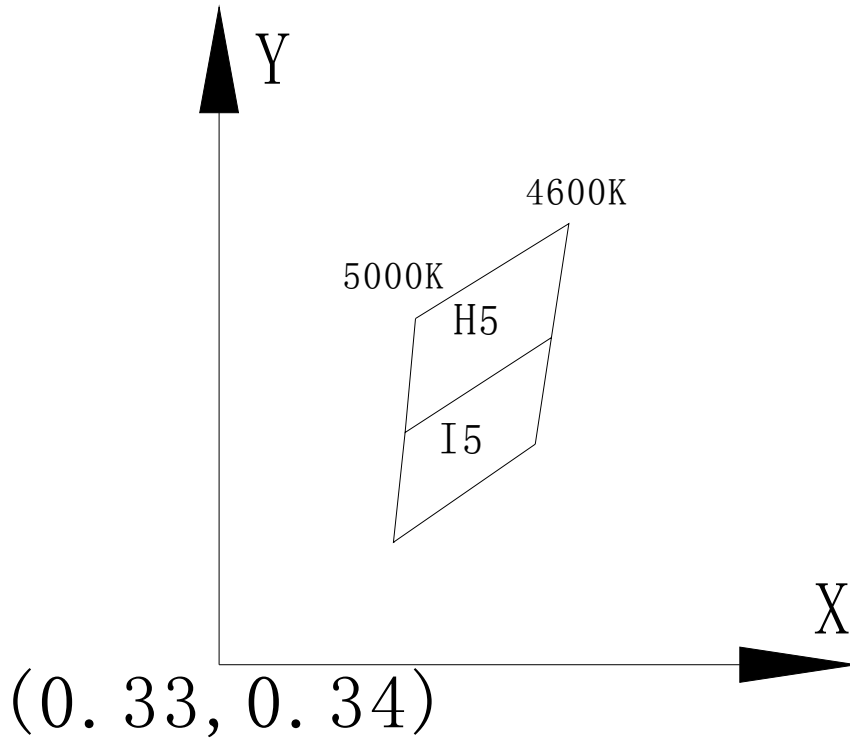

**Bin data:**

| BIN CODE | CIE-X1 | CIE-Y1 | CIE-X2 | CIE-Y2 | CIE-X3 | CIE-Y3 | CIE-X4 | CIE-Y4 |
|----------|--------|--------|--------|--------|--------|--------|--------|--------|
| H5       | 0.3601 | 0.3818 | 0.3469 | 0.3728 | 0.3460 | 0.3620 | 0.3586 | 0.3710 |
| I5       | 0.3586 | 0.3710 | 0.3460 | 0.3620 | 0.3450 | 0.3516 | 0.3572 | 0.3609 |

**Optical characteristics curves**

**Forward Current VS Forward Voltage**



**Relative Flux VS Forward Current**

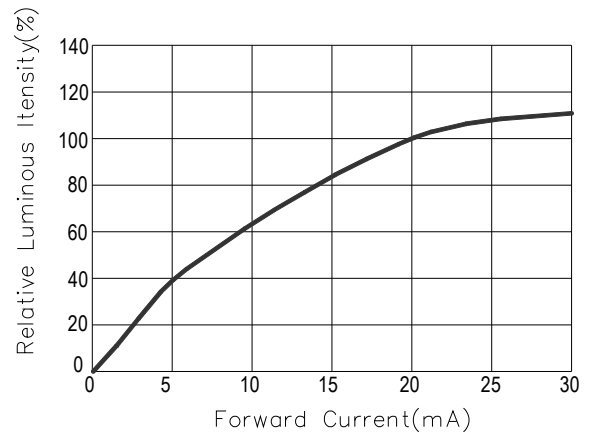

**Relative Flux VS Ambient Temperature**

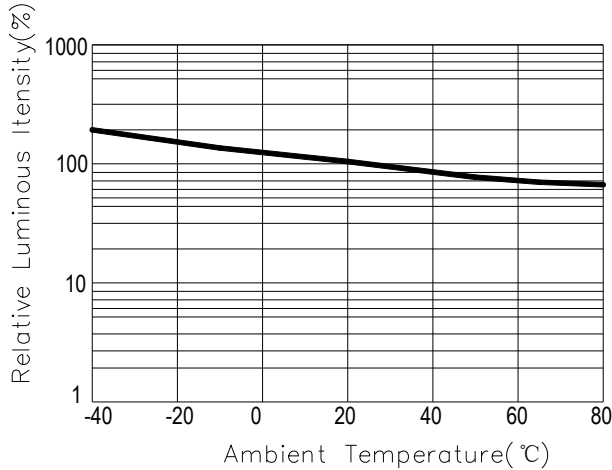

**Forward Current VS Ambient Temperature**

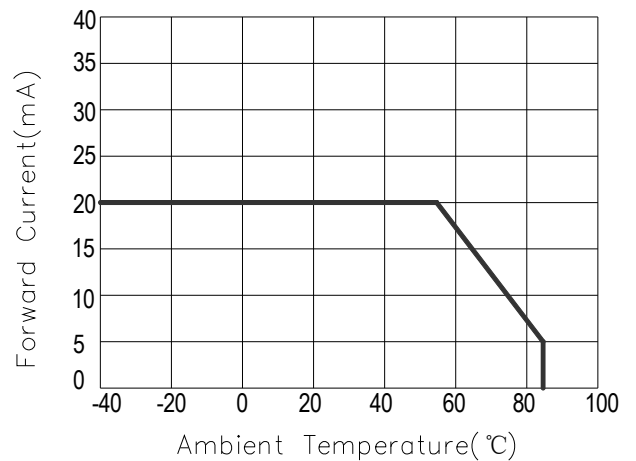

**Relative Spectral Distribution**

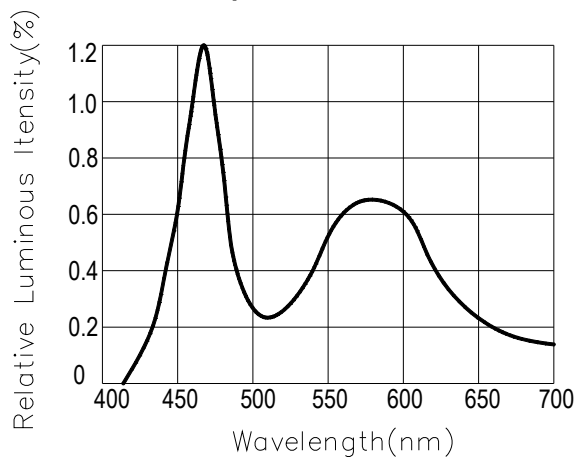

**Typical Spectral Distribution**

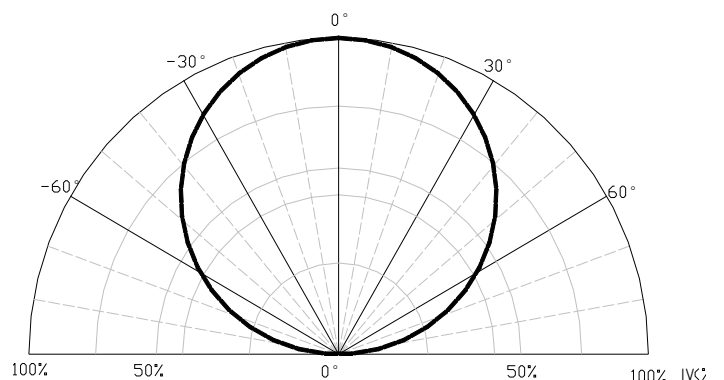

## Packaging Specifications

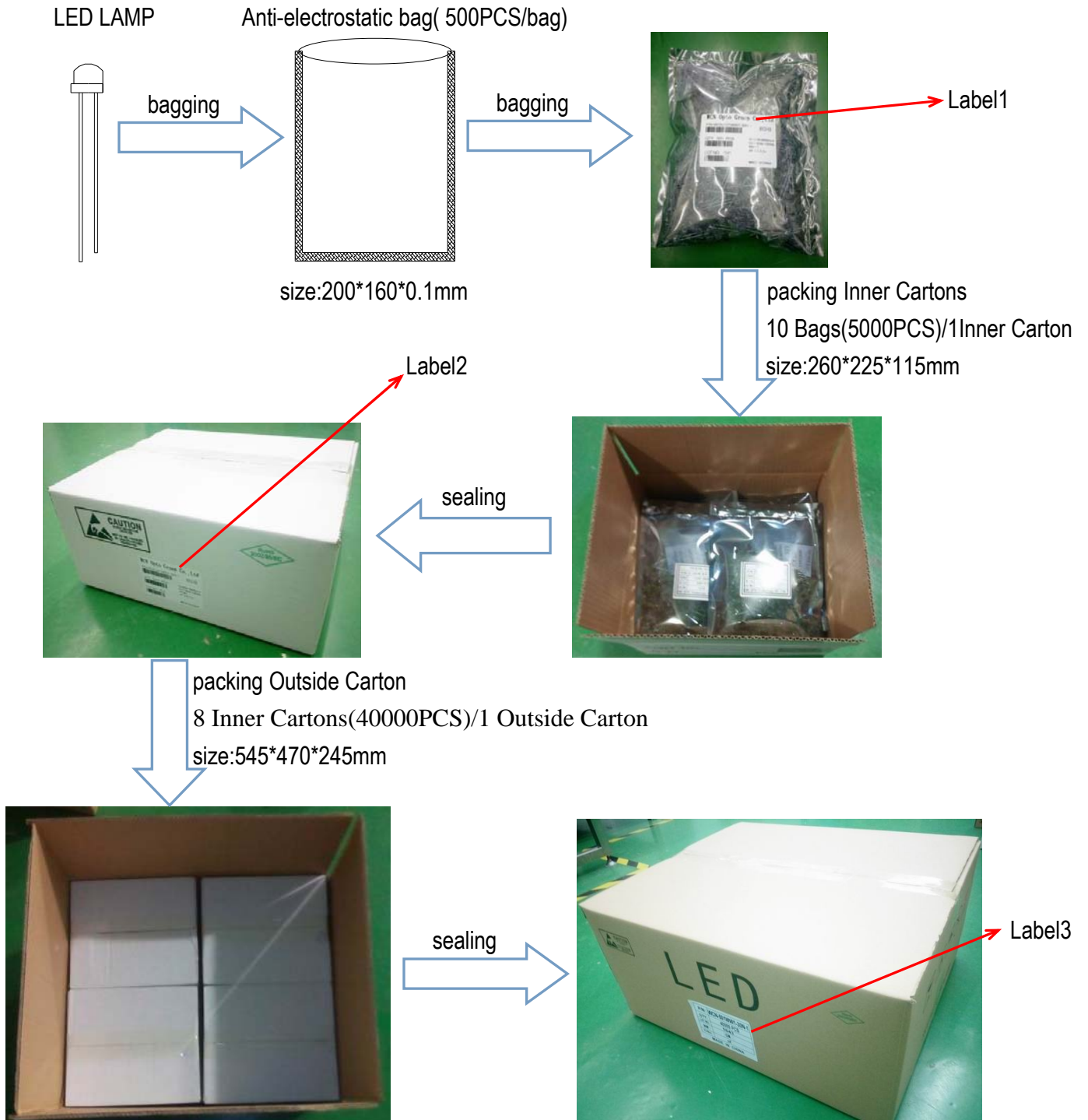





# WCN Opto Group Co., Ltd

## Label1:

WCN Opto Group Co., Ltd

P/N: ROHS



QTY: PCS IV:  
 CCT:  
BIN:  
VF:

LOT NO:  
 MADE IN CHINA

|        |                              |
|--------|------------------------------|
| P/N    | Part Number                  |
| QTY    | Packing Quantity             |
| LOT NO | Made Date                    |
| IV     | Luminous intensity           |
| CCT    | Correlated Color Temperature |
| BIN    | Bin Code                     |
| VF     | Forward Voltage              |

## Label2:

WCN Opto Group Co., Ltd

P/N: ROHS



QTY: PCS IV:  
 CCT:  
BIN:  
VF:

LOT NO:  
 MADE IN CHINA

## Label3:

|         |     |
|---------|-----|
| P/N:    |     |
| QTY:    |     |
| LOT NO: |     |
| NW:     | GW: |
| C/NO:   | Of: |

MADE IN CHINA

|        |                  |
|--------|------------------|
| P/N    | Part Number      |
| QTY    | Packing Quantity |
| LOT NO | Made Date        |
| NW     | Net weight       |
| GW     | Gross weight     |
| C/NO   | Container number |

## Test items and results of reliability

| Type                   | Test Item                    | Test Conditions                   | Note      | Number of Damaged |
|------------------------|------------------------------|-----------------------------------|-----------|-------------------|
| Environmental Sequence | Temperature Cycle            | -20°C 30min<br>↑↓<br>105°C 30min  | 100 cycle | 0/22              |
|                        | Thermal Shock                | -20°C 15min<br>↑↓<br>105°C 15min  | 100 cycle | 0/22              |
|                        | High Humidity Heat Cycle     | 30°C ↔ 65°C<br>90%RH 24hrs/1cycle | 10 cycle  | 0/22              |
|                        | High Temperature Storage     | Ta=105°C                          | 1000 hrs  | 0/22              |
|                        | Humidity Heat Storage        | Ta=60°C<br>RH=90%                 | 1000 hrs  | 0/22              |
|                        | Low Temperature Storage      | Ta=-30°C                          | 1000 hrs  | 0/22              |
| Operation Sequence     | Life Test                    | Ta=25°C<br>IF=20mA                | 1000 hrs  | 0/22              |
|                        | High Humidity Heat Life Test | 60°C RH=90%<br>IF=10mA            | 500 hrs   | 0/22              |
|                        | Low Temperature Life Test    | Ta=-20°C<br>IF=20mA               | 1000 hrs  | 0/22              |



**PRECAUTIONS**

1. The lead pitch of the LED must match the pitch of the mounting holes on the PCB during component. Lead-forming may be required to insure the lead pitch matches the hole pitch. Refer to the figure below for proper lead forming procedures.(Fig. 1)

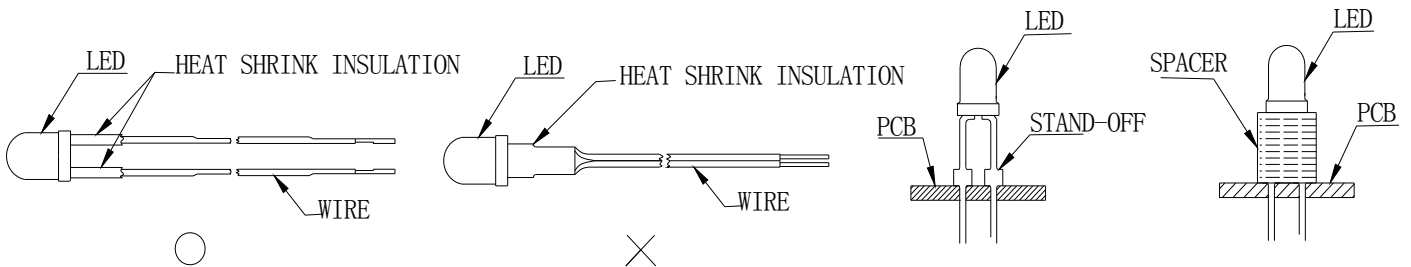

**Fig. 1**

“O” Correct mounting method      “x” Incorrect mounting method

2. When soldering wire to the LED, use individual heat-shrink tubing to insulate the exposed leads to prevent accidental contact short-circuit.(Fig. 2)

3. Use stand-offs (Fig. 3) or spacers (Fig. 4) to securely position the LED above the PCB.



**Fig. 2**

**Fig. 3**

**Fig. 4**

4. Maintain a minimum of 3mm clearance between the base of the LED lens and the first lead bend.(Fig. 5 and 6)

5. During lead forming, use tools or jigs to hold the leads securely so that the bending force will not be transmitted to the LED lens and its internal structures. Do not perform lead forming once the component has been mounted onto the PCB.(Fig. 7)

6. Do not bend the leads more than twice.(Fig. 8)

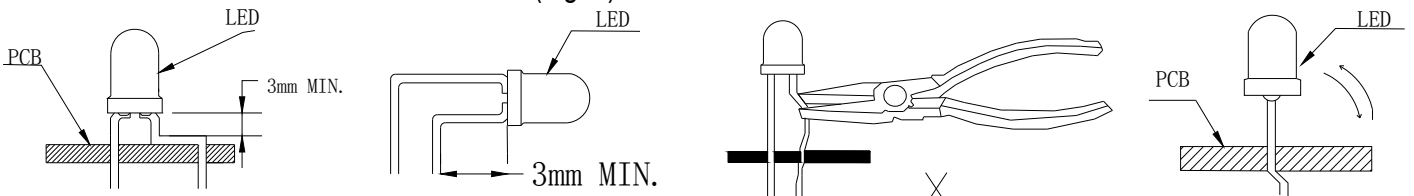

**Fig. 5**

**Fig. 6**

**Fig. 7**

**Fig. 8**

7. During soldering, component covers and holders should leave clearance to avoid placing damaging stress on the LED during soldering.



8. The tip of the soldering iron should never touch the lens epoxy.

9. Through-hole LEDs are incompatible with reflow soldering.

10. If the LED will undergo multiple soldering passes or face other processes where the part may be subjected to intense heat, please check with WCN for compatibility.

11. Recommended Wave Soldering Profiles:

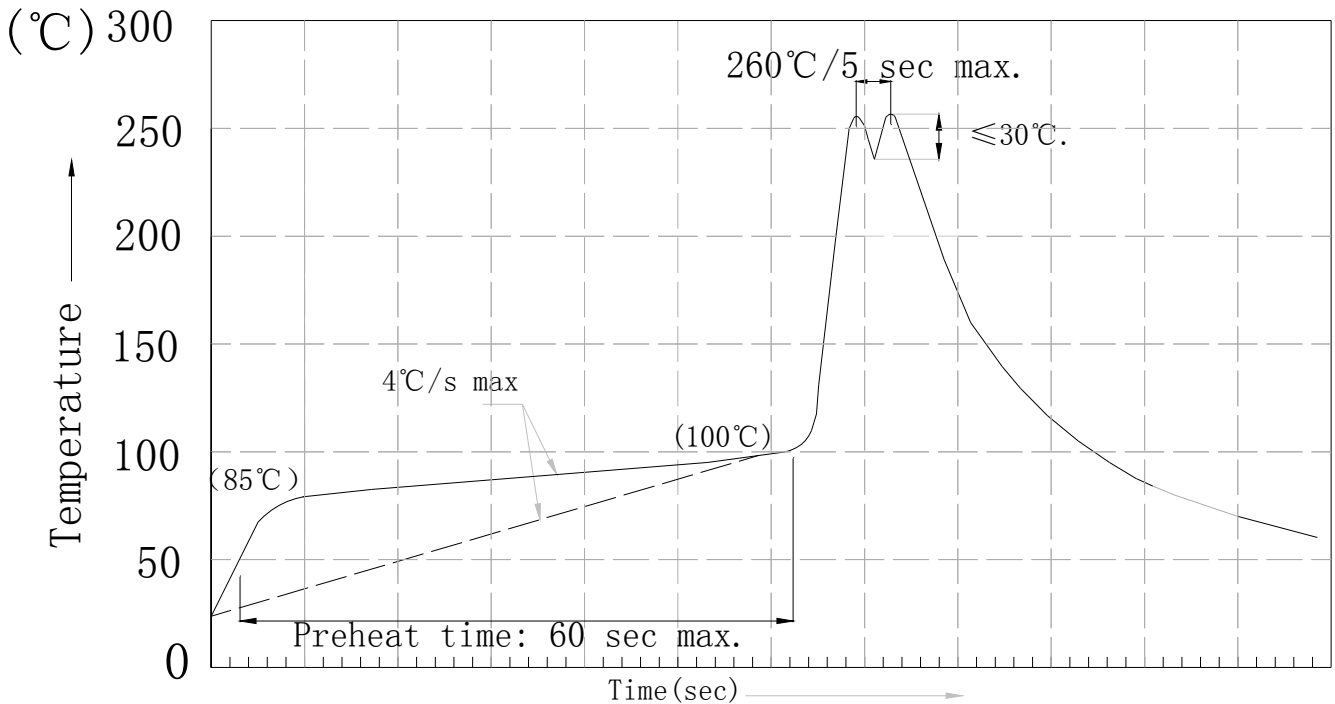

Notes:

1. Recommend pre-heat temperature of 105°C or less (as measured with a thermocouple attached to the LED pins) prior to immersion in the solder wave with a maximum solder bath temperature of 260°C.
2. Peak wave soldering temperature between 250°C ~ 260°C for 3 sec (5 sec max).
3. Do not apply stress to the epoxy resin while the temperature is above 85°C.
4. Fixtures should not incur stress on the component when mounting and during soldering process.
5. No more than one time to pass the wave soldering.