

**WCN-1206IR-0E-1000****SPECIFICATION**

WCN			CUSTOMER Confirmed
Prepared by	Checked by	Approved by	
LiuGuo 2018-11-9	ZhangChun 2018-11-9		



## Description

- ◆ Viewing angle: 120 deg
- ◆ The materials of the LED dice is AlGaAs
- ◆ 3.2mm×1.6mm×1.1mm
- ◆ RoHS compliant lead-free soldering compatible

## Package Outline

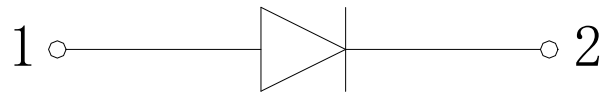
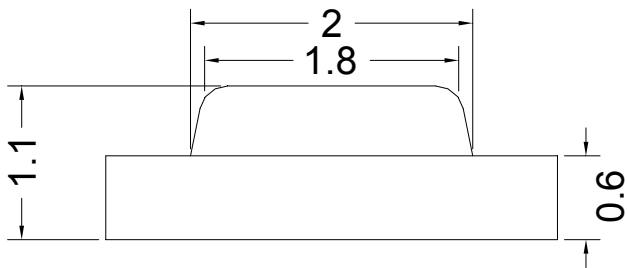
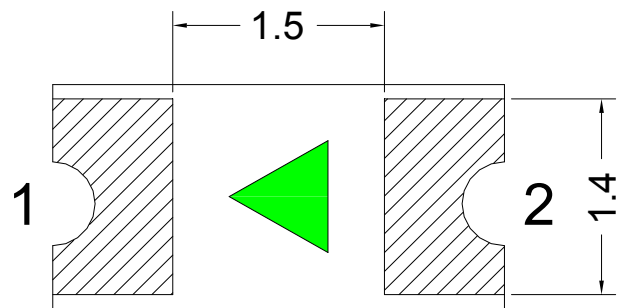
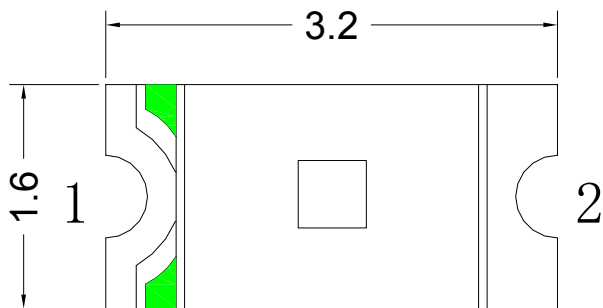

## NOTES:

1. All dimensions units are millimeters ;
2. All dimensions tolerances are  $\pm 0.2\text{mm}$  unless otherwise noted.

## Absolute Maximum Ratings at Ta=25°C

Parameter	Symbol	Rating	Units
Power Dissipation	Pd	57	mW
Forward current	IF	30	mA
Peak Forward Current	IFP	100	mA
Reverse voltage	VR	5	V
Electrostatic Discharge	ESD	1000	V
Operating temperature	Topr	-30~+85	°C
Storage temperature	Tstg	-40 ~+100	°C

## Electrical/Optical characteristics at Ta=25°C

Item	test condition	Symbol	Value			Unit
			Min.	Typ.	Max.	
Forward voltage	If=20mA	Vf	1.3	--	1.5	V
			1.5	--	1.7	V
			1.7	--	1.9	V
Radiant Intensity	If=20mA	IE	0.8	--	1.2	mW/sr
Peak Emission Wavelength	If=20mA	$\lambda_p$	1000	--	1030	nm
Reverse current	Vr=5V	Ir	--	--	10	$\mu$ A
Viewing angle at 50% Iv	If=20mA	2 $\theta$ 1/2	--	120	--	Deg

### NOTE:

- 1.1/10 Duty cycle, 0.1ms pulse width.
2. The above forward voltage measurement allowance tolerance is 0.1V.
3. the above luminous intensity measurement allowance tolerance  $\pm 10\%$ .

**Optical characteristics curves**

**Forward Current VS Forward Voltage**

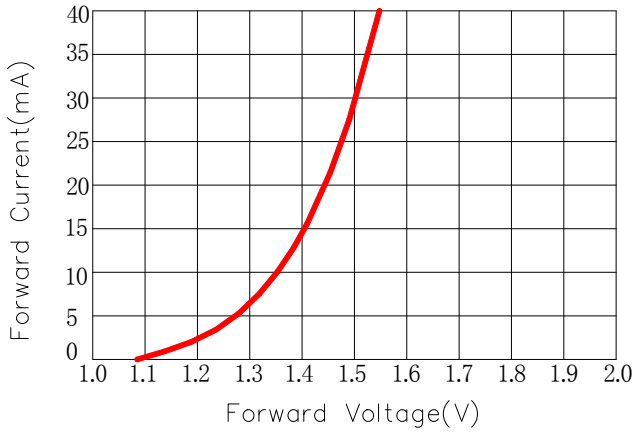

**Relative Flux VS Forward Current**

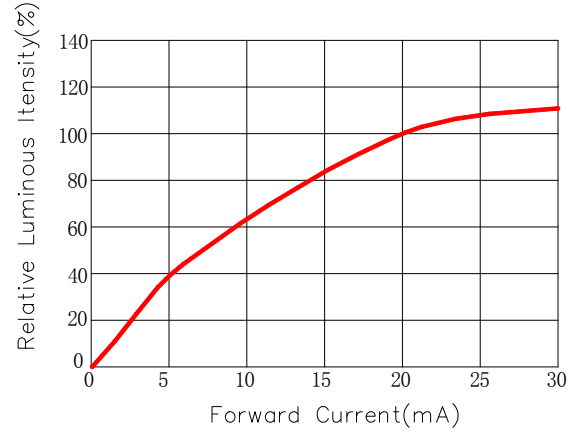

**Relative Flux VS Ambient Temperature**

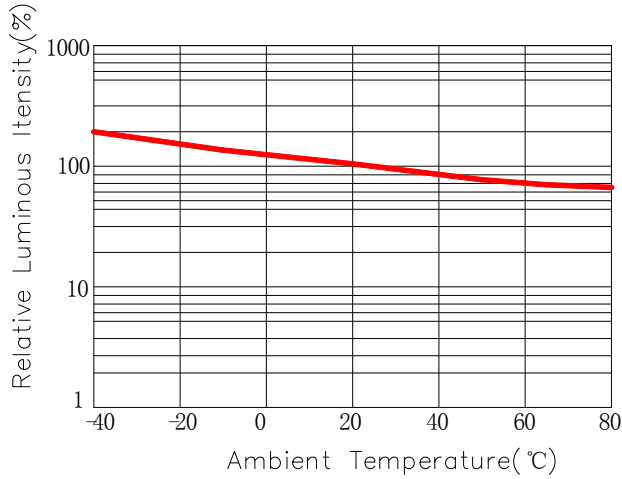

**Forward Current VS Ambient Temperature**

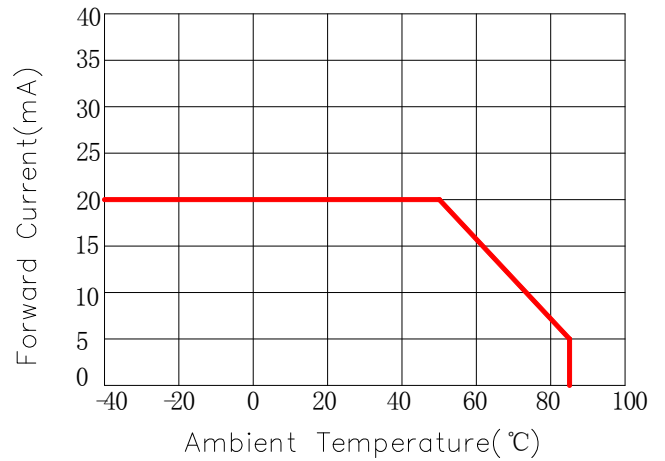

**Relative Spectral Distribution**

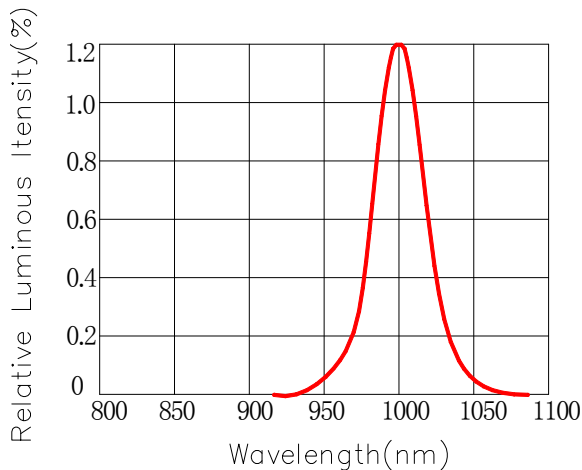

**Typical Spectral Distribution**

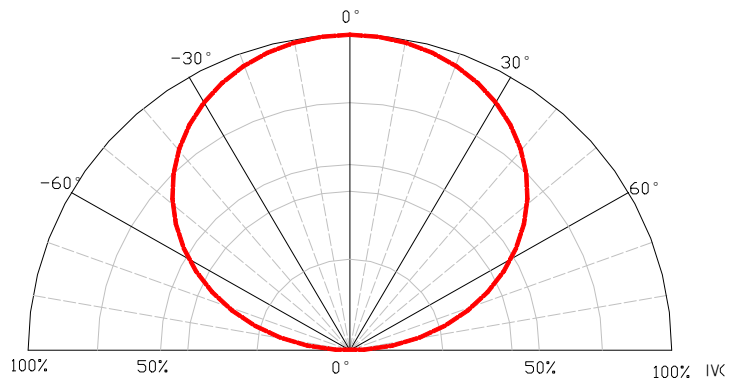

**Packaging Specifications**

■ **Carrier Tape Dimensions**

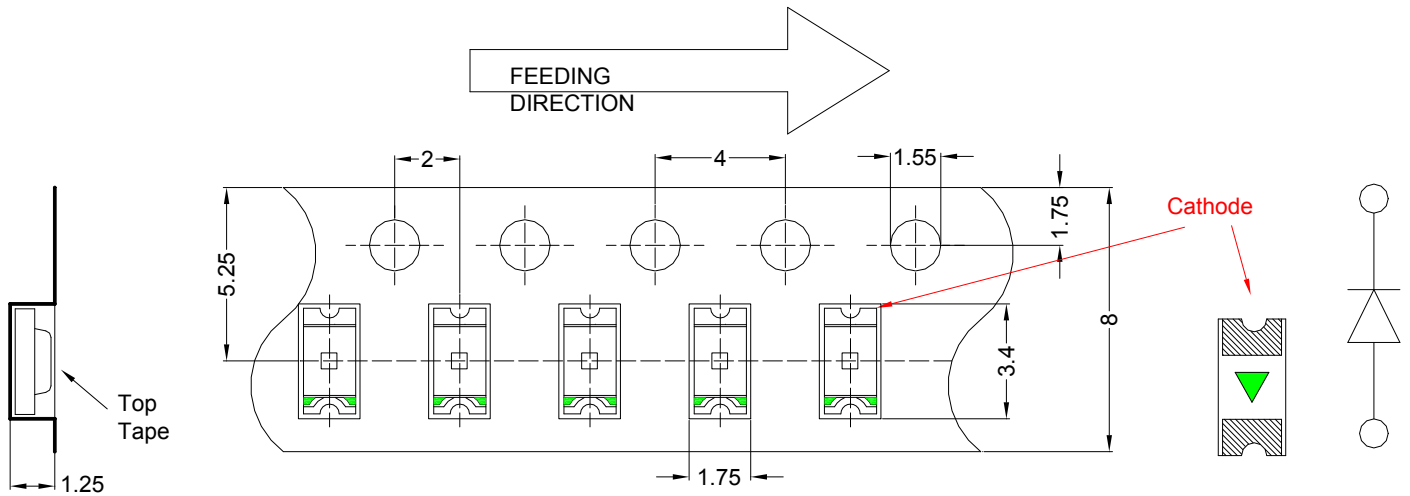

■ **Reel Dimension**

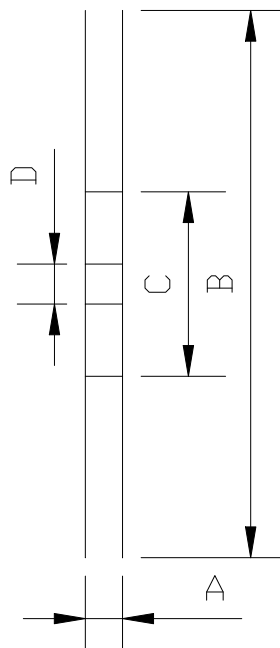
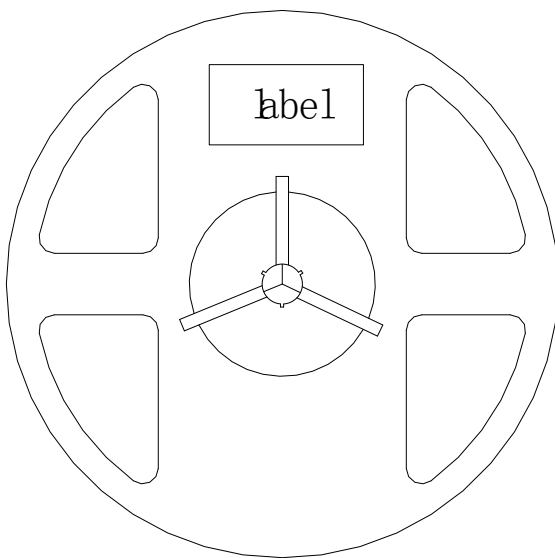

A	8.0±0.1mm
B	178±1mm
C	60±1mm
D	13.0±0.5mm

**NOTE:**

1. The tolerances unless mentioned  $\pm 0.1$ mm. Unit : mm
2. 3,000 pcs/Reel.

## Label Form Specification

WCN Opto Group Co., Ltd

P/N: \_\_\_\_\_ ROHS



QTY:      PCS      IV: \_\_\_\_\_  
   WL: \_\_\_\_\_  
   VF: \_\_\_\_\_

LOT NO: \_\_\_\_\_



MADE IN CHINA

P/N	Part Number
QTY	Packing Quantity
LOT NO	Made Date
IV	Luminous intensity
WL	Peak Emission Wavelength
VF	Forward Voltage

## Moisture Resistant Packing Process

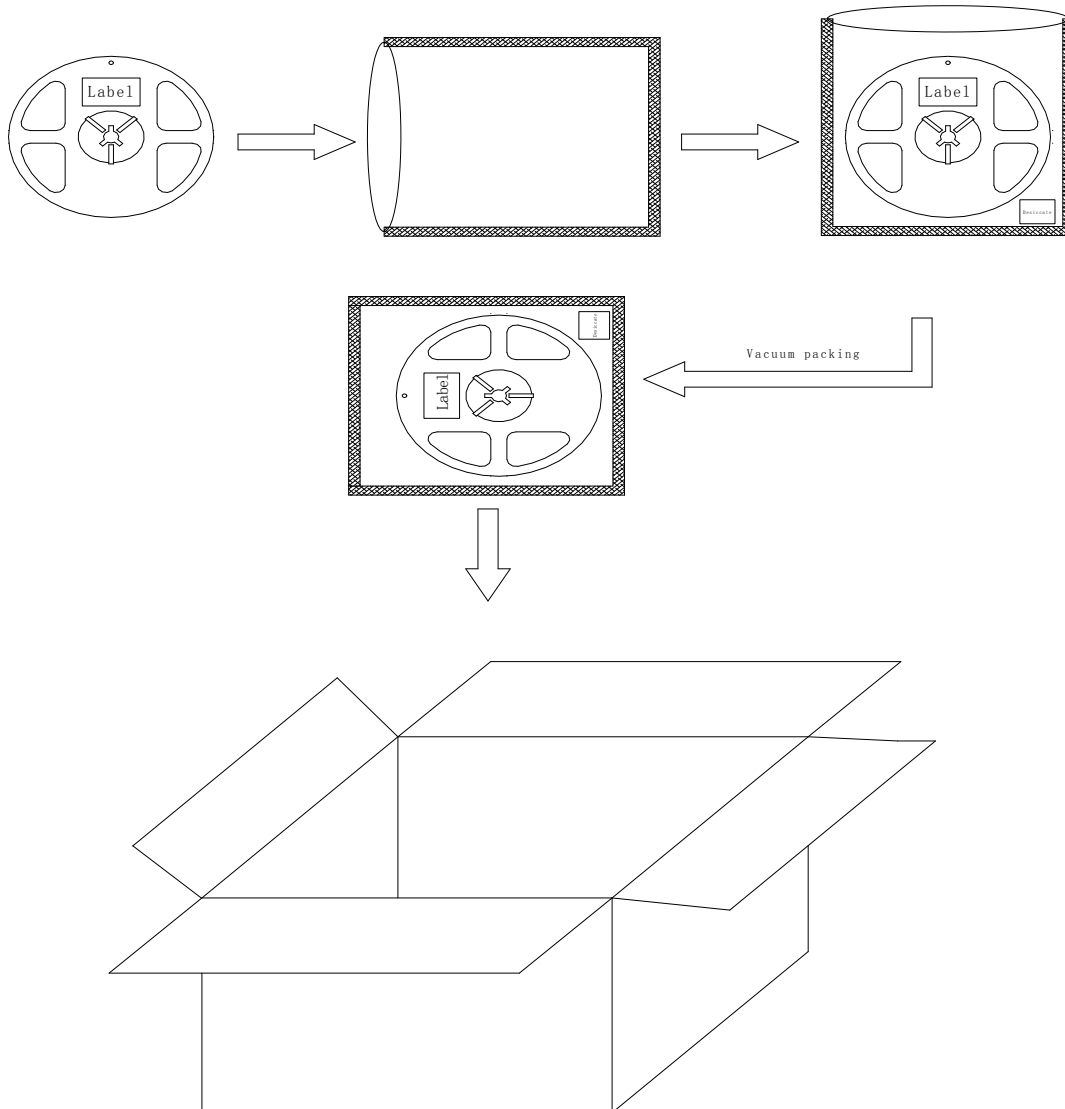

## Test items and results of reliability

Type	Test Item	Test Conditions	Note	Number of Damaged
Environmental Sequence	Reflow	Ta=260°C max T=10s	2 times	0/22
	Temperature Cycle	-40°C 30min ↑↓ 100°C 30min	100 cycle	0/22
	Thermal Shock	-40°C 15min ↑↓ 100°C 15min	100 cycle	0/22
	High Humidity Heat Cycle	30°C ↔ 65°C 90%RH 24hrs/1cycle	10 cycle	0/22
	High Temperature Storage	Ta=100°C	1000 hrs	0/22
	Low Temperature Storage	Ta=-40°C	1000 hrs	0/22
	Humidity Heat Storage	Ta=60°C RH=90%	1000 hrs	0/22
	Low Temperature Storage	Ta=-30°C	1000 hrs	0/22
Operation Sequence	Life Test	Ta=25°C IF=20mA	1000 hrs	0/22
	High Humidity Heat Life Test	60°C RH=90% IF=10mA	500 hrs	0/22
	Low Temperature Life Test	Ta=-20°C IF=20mA	1000 hrs	0/22

## Reflow Profile

### ■ Reflow Temp/Time



### Notes:

1. We recommend the reflow temperature 245°C (±5°C). the maximum soldering temperature should be limited to 260°C.
2. Don't cause stress to the epoxy resin while it is exposed to high temperature.
3. Number of reflow process shall be 2 times or less.

### ■ Soldering iron

Basic spec is  $\leq 5\text{sec}$  when 260°C. If temperature is higher, time should be shorter (+10°C → -1sec). Power dissipation of iron should be smaller than 20W, and temperatures should be controllable. Surface temperature of the device should be under 230°C.

### ■ Rework

1. Customer must finish rework within 5 sec under 260°C.
2. The head of iron can not touch copper foil
3. Twin-head type is preferred.

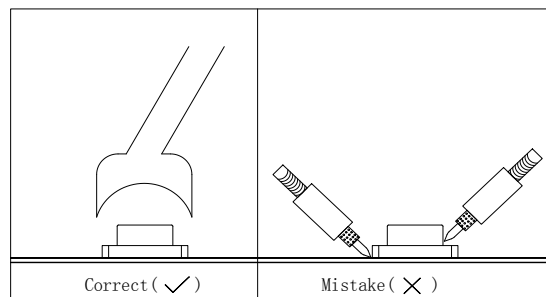

■ Avoid rubbing or scraping the resin by any object, during high temperature, for example reflow solder etc.



**Test circuit and handling precautions**

## ■ Test circuit



## ■ Handling precautions

## 1. Over-current-proof

Customer must apply resistors for protection; otherwise slight voltage shift will cause big current change (Burn out will happen).

## 2. Storage

2.1 It is recommended to store the products in the following conditions:

Humidity: 60% R.H. Max.

Temperature : 5°C~30°C (41°F~86°F)

2.2 Shelf life in sealed bag: 12 month at <5°C~30°C and <30% R.H. After the package is

Opened, the products should be used within a week or they should be keeping to stored at  $\leq 20$  R.H. with zip-lock sealed.

## 3. Baking

It is recommended to baking before soldering when the pack is unsealed after 72hrs. The Conditions are as followings:

3.1 70 $\pm$ 3°C x(12~24hrs) and <5%RH, taped reel type

3.2 100 $\pm$ 3°C x(45min~1hr), bulk type

3.3 130 $\pm$ 3°C x(15~30min), bulk type