

**WCN-307HR3-50N****SPECIFICATION**

WCN			CUSTOMER Confirmed
Prepared by	Checked by	Approved by	
LiuGuo 2018-11-9	ZhangChun 2018-11-9		



## Selection Guide

Part No.	Dice		Lens Color	Iv(mcd)(If=20mA)			Viewing angle (2θ1/2)
	Raw Material	Emitted Color		Min	Typ	Max	
WCN-307HR3-50N	AlGaInP	Red	Clear lens with tint	15	---	100	50°

## Package Outline

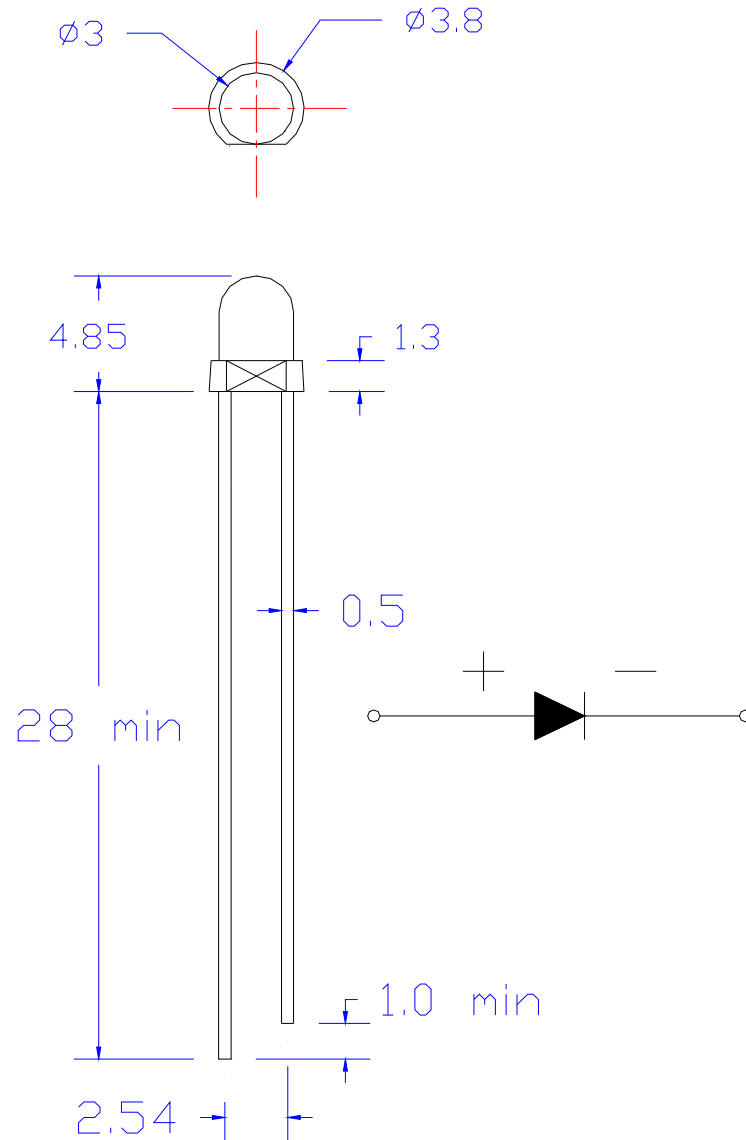

### NOTES:

1. All dimensions units are millimeters ;
2. All dimensions tolerances are  $\pm 0.2\text{mm}$  unless otherwise noted.

## Absolute Maximum Ratings at Ta=25°C

Parameter	Symbol	Rating	Units
Power Dissipation	Pd	48	mW
Forward current	IF	20	mA
Peak Forward Current	IFP	100	mA
Reverse voltage	VR	5	V
Electrostatic Discharge	ESD	1000	V
Operating temperature	Topr	-30~+85	°C
Storage temperature	Tstg	-40 ~+100	°C

## Electrical/Optical characteristics at Ta=25°C

Item	test condition	Symbol	Value			Unit
			Min.	Typ.	Max.	
Forward voltage	If=20mA	Vf	1.8	--	2.0	V
			2.0	--	2.2	V
			2.2	--	2.4	V
Luminous intensity	If=20mA	Iv	15	--	30	mcd
			30	--	40	mcd
			40	--	60	mcd
			60	--	100	mcd
Dominant wavelength	If=20mA	λd	637.5	--	640	nm
			640	--	642.5	nm
			642.5	--	645	nm
Reverse current	Vr=5V	Ir	--	--	10	μA
Viewing angle at 50% Iv	If=20mA	2 θ1/2	--	50	--	Deg

### NOTE:

- 1.1/10 Duty cycle, 0.1ms pulse width.
2. The above forward voltage measurement allowance tolerance is 0.1V.
3. the above luminous intensity measurement allowance tolerance ±10%.

**Optical characteristics curves**

**Forward Current VS Forward Voltage**

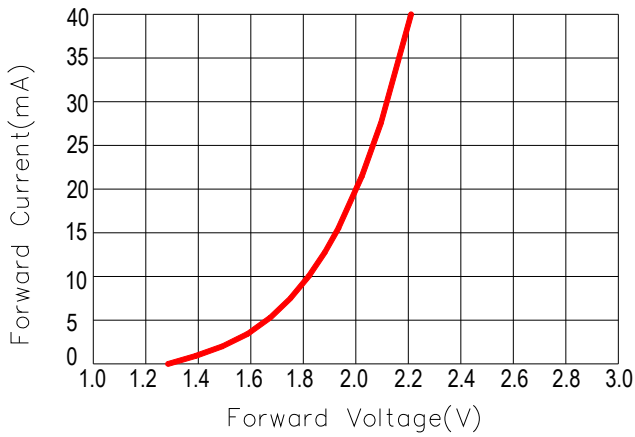

**Relative Flux VS Forward Current**

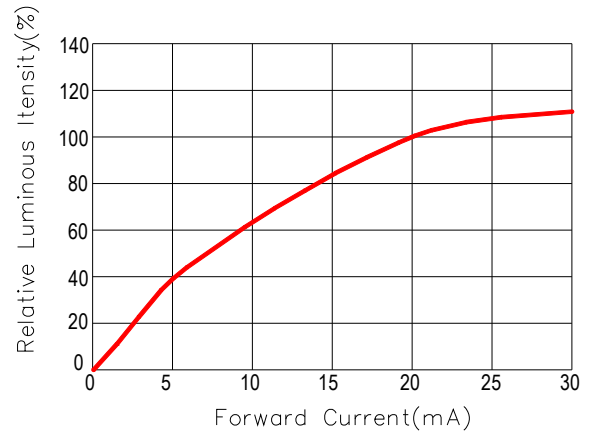

**Relative Flux VS Ambient Temperature**

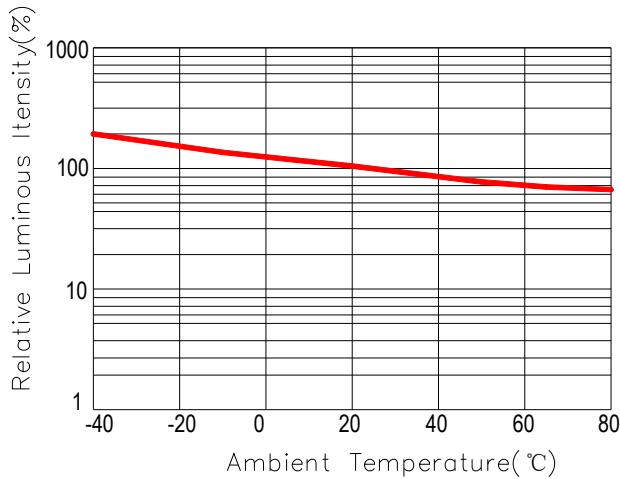

**Forward Current VS Ambient Temperature**

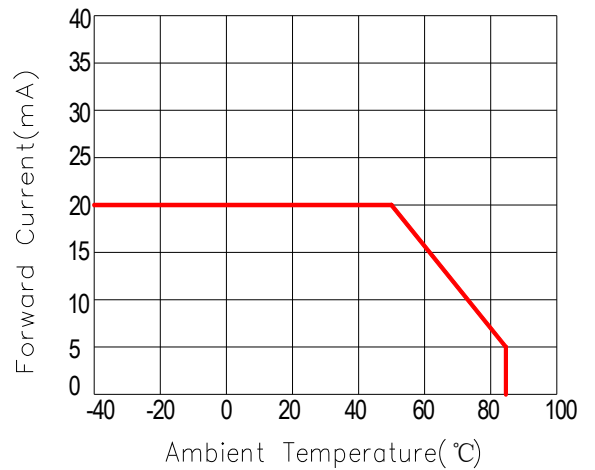

**Relative Spectral Distribution**

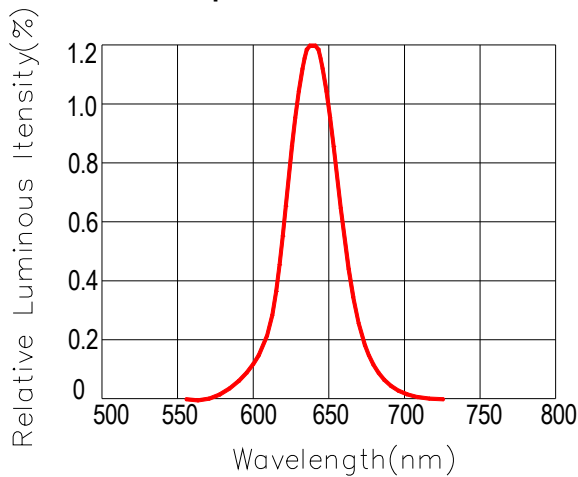

**Typical Spectral Distribution**

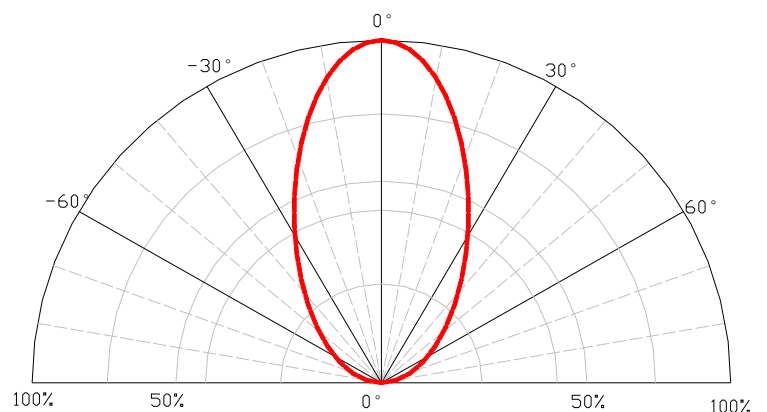

## Packaging Specifications





## Test items and results of reliability

Type	Test Item	Test Conditions	Note	Number of Damaged
Environmental Sequence	Temperature Cycle	-20°C 30min ↑↓ 105°C 30min	100 cycle	0/22
	Thermal Shock	-20°C 15min ↑↓ 105°C 15min	100 cycle	0/22
	High Humidity Heat Cycle	30°C ↔ 65°C 90%RH 24hrs/1cycle	10 cycle	0/22
	High Temperature Storage	Ta=105°C	1000 hrs	0/22
	Humidity Heat Storage	Ta=60°C RH=90%	1000 hrs	0/22
	Low Temperature Storage	Ta=-30°C	1000 hrs	0/22
Operation Sequence	Life Test	Ta=25°C IF=20mA	1000 hrs	0/22
	High Humidity Heat Life Test	60°C RH=90% IF=10mA	500 hrs	0/22
	Low Temperature Life Test	Ta=-20°C IF=20mA	1000 hrs	0/22

**PRECAUTIONS**

1. The lead pitch of the LED must match the pitch of the mounting holes on the PCB during component. Lead-forming may be required to insure the lead pitch matches the hole pitch. Refer to the figure below for proper lead forming procedures.(Fig. 1)

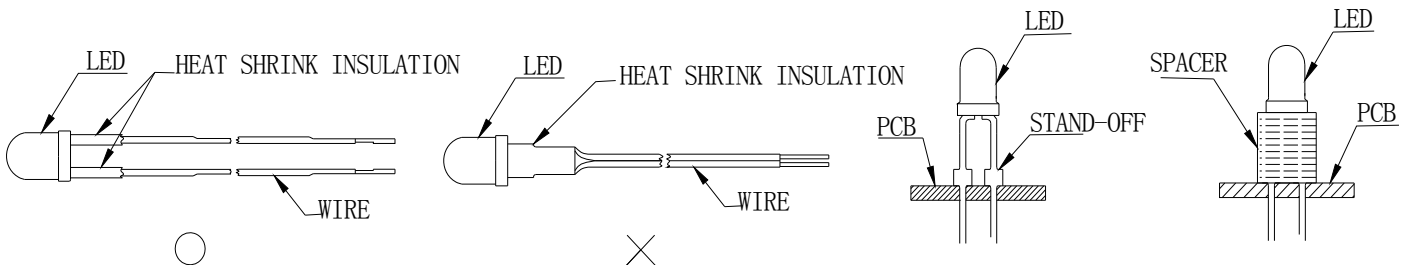

**Fig. 1**

“O” Correct mounting method      “x” Incorrect mounting method

2. When soldering wire to the LED, use individual heat-shrink tubing to insulate the exposed leads to prevent accidental contact short-circuit.(Fig. 2)

3. Use stand-offs (Fig. 3) or spacers (Fig. 4) to securely position the LED above the PCB.



**Fig. 2**

**Fig. 3**

**Fig. 4**

4. Maintain a minimum of 3mm clearance between the base of the LED lens and the first lead bend.(Fig. 5 and 6)

5. During lead forming, use tools or jigs to hold the leads securely so that the bending force will not be transmitted to the LED lens and its internal structures. Do not perform lead forming once the component has been mounted onto the PCB.(Fig. 7)

6. Do not bend the leads more than twice.(Fig. 8)

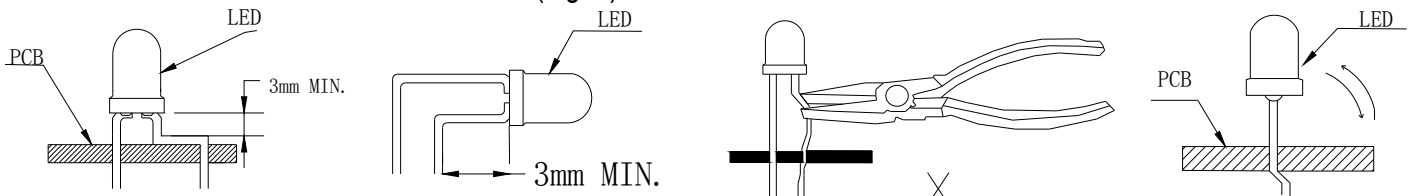

**Fig. 5**

**Fig. 6**

**Fig. 7**

**Fig. 8**

7. During soldering, component covers and holders should leave clearance to avoid placing damaging stress on the LED during soldering.





8. The tip of the soldering iron should never touch the lens epoxy.

9. Through-hole LEDs are incompatible with reflow soldering.

10. If the LED will undergo multiple soldering passes or face other processes where the part may be subjected to intense heat, please check with WCN for compatibility.

11. Recommended Wave Soldering Profiles:

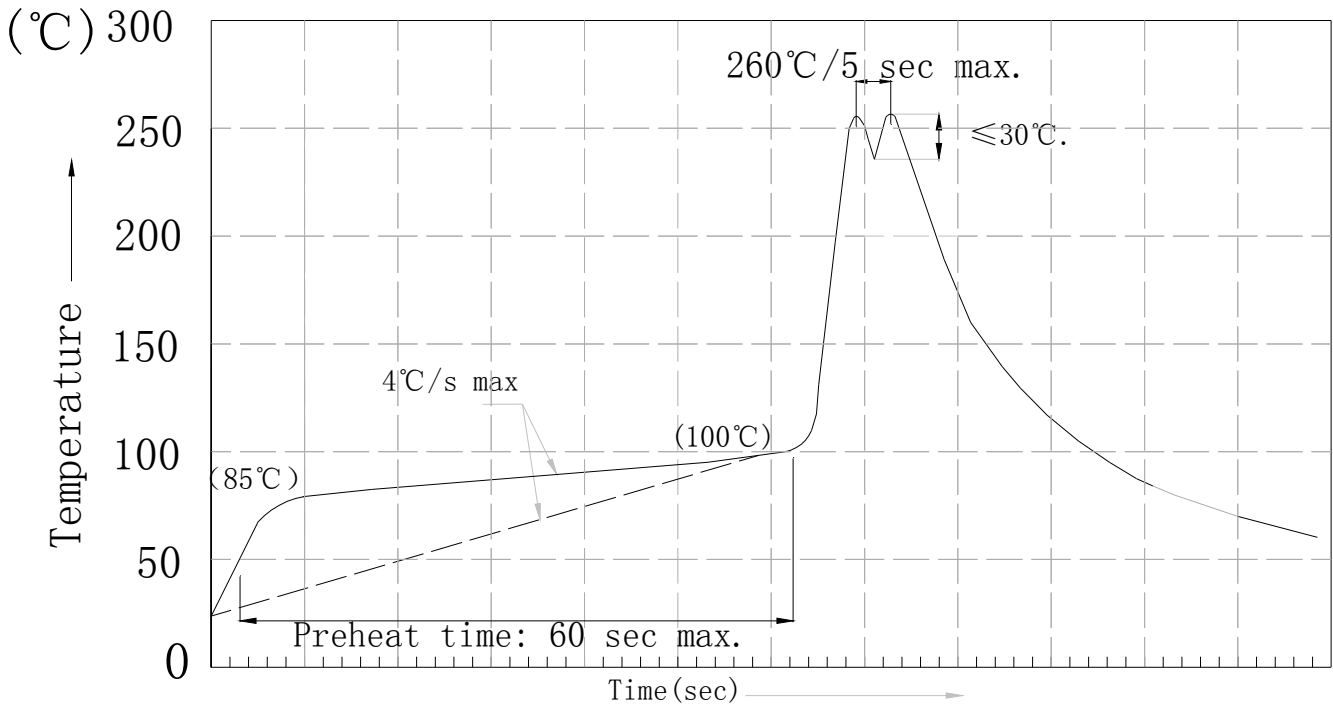

Notes:

1. Recommend pre-heat temperature of 105°C or less (as measured with a thermocouple attached to the LED pins) prior to immersion in the solder wave with a maximum solder bath temperature of 260°C.
2. Peak wave soldering temperature between 250°C ~ 260°C for 3 sec (5 sec max).
3. Do not apply stress to the epoxy resin while the temperature is above 85°C.
4. Fixtures should not incur stress on the component when mounting and during soldering process.
5. No more than one time to pass the wave soldering.