

WCN4-1052GU-A31

SPECIFICATION

| WCN | | | CUSTOMER Confirmed |
|--------------------------------|-------------------|--------------------|-------------------------------|
| Prepared by | Checked by | Approved by | |
| Fei 2016-4-18 | Athena | William | |
| REVISION RECORD | | | |

**REVISION: A0**

Outer Dimension:

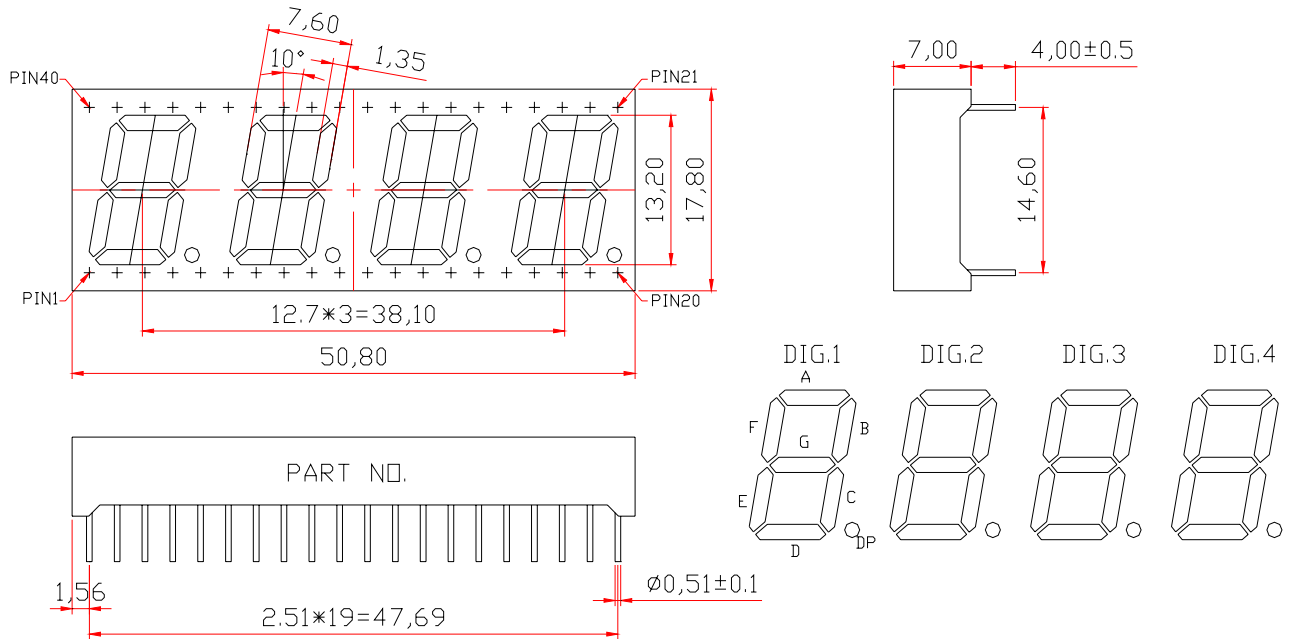

Notes: Unless otherwise stated, The tolerance is $\pm 0.25\text{mm}$.

Circuit Diagram:

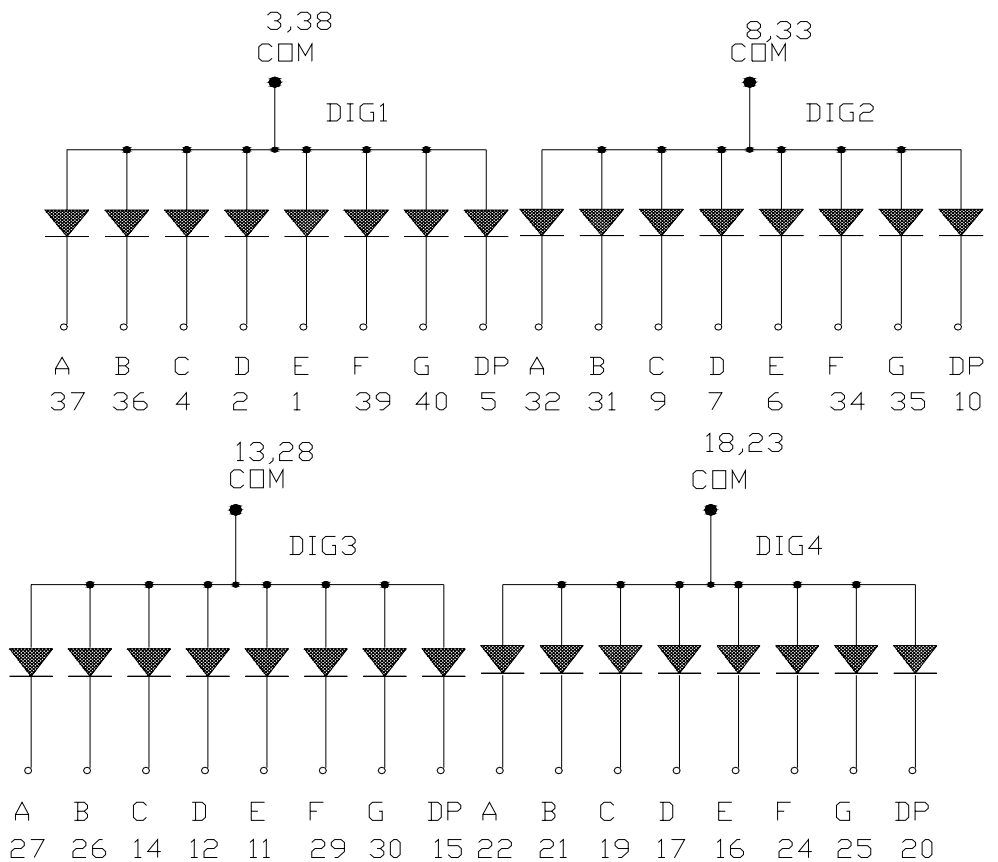

■ **Features:**

- High Reliability
- Color: Yellow Green
- Low Power Requirement
- Easy Assembly

■ **Description:**

- Four Digit Display
- Digit Height: 13.2mm(0.52")
- Gray Face and Milky Segment

■ **Absolute Maximum Rating (Ta=25°C):**

| Parameter | Symbol | Condition | Color | Rating | Units |
|----------------------------------|------------------|--------------------|--------------|---------|-------|
| Power Dissipation Per Segment | P _d | — | Yellow Green | 65 | mW |
| Forward Current Per Segment | I _F | — | Yellow Green | 25 | mA |
| Peak Forward Current Per Segment | I _{FP} | 1/10 Duty 10KHz | Yellow Green | 100 | mA |
| Reverse Voltage Per Segment | V _R | — | Yellow Green | 5 | V |
| Operating Temperature Range | T _{opr} | — | — | -35~+85 | °C |
| Storage Temperature Range | T _{stg} | — | — | -35~+85 | °C |

■ **Electrical/Optical Characteristics Rating(Ta=25°C)**

| Item | Symbol | Test conditions | Location | Rating | | | Units |
|--|------------------|----------------------|-------------|--------|------|-------|-------|
| | | | | Min. | Typ. | Max. | |
| Forward Voltage | V _F | I _F =20mA | Per Segment | — | 2.25 | 2.60 | V |
| Reverse Current | I _R | V _R =5V | Per Segment | — | — | 100 | μA |
| Luminous Intensity | I _V | I _F =10mA | Per Segment | 1751 | 3500 | 6100 | μcd |
| Peak Emission Wave Length | λ _P | I _F =20mA | Per Segment | — | 568 | — | nm |
| | λ _D | | | — | 571 | — | |
| Spectral Line Half Width | △λ | I _F =20mA | Per Segment | — | 20 | — | nm |
| Luminous Intensity Matching Ratio (Segment to Segment) | I _{v-m} | I _F =10mA | — | — | — | 1.2:1 | |

■ **Luminous Intensity Sorting: (Luminous Intensity Tolerance is +/-10%)**

| Rank | Symbol | Condition | Min | Max | Unit |
|------|--------|----------------------|------|------|------|
| I | I | I _F =10mA | 1751 | 2350 | μcd |
| J | J | I _F =10mA | 2351 | 3050 | μcd |
| K | K | I _F =10mA | 3051 | 4000 | μcd |
| L | L | I _F =10mA | 4001 | 5000 | μcd |
| M | M | I _F =10mA | 5001 | 6100 | μcd |

■ **Hue Grade: I_F =10mA (Hue: +/-1nm)**

| Rank | Symbol | Hue Range | Units |
|------|--------|-------------|-------|
| 3 | 3 | 569.1~571.0 | nm |
| 4 | 4 | 571.1~573.0 | nm |

■ **Soldering Conditions: Soldering Temp. ≤+260°C, Soldering Time. ≤3sec.**
 (at 2mm Distance from The Case of Reflector Edge)

Typical Elector-Optical Characteristics Curve:

Fig 1. Forward Current vs. Forward Voltage

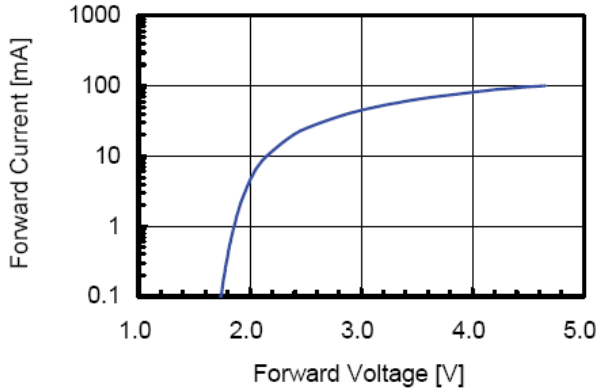

Fig 2. Relative Intensity vs. Forward Current

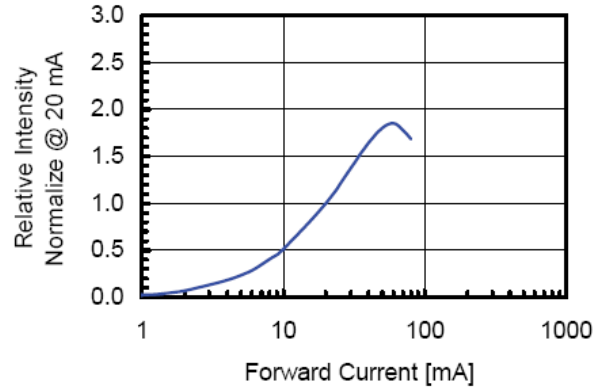

Fig 3. Forward Voltage vs. Temperature

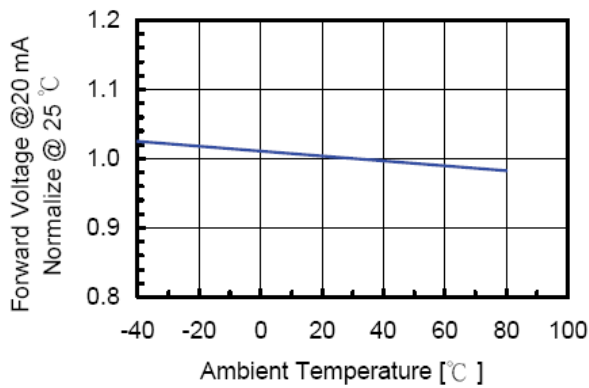

Fig 4. Relative Intensity vs. Temperature

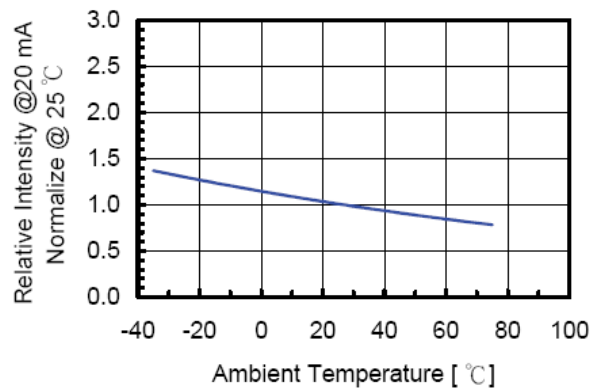
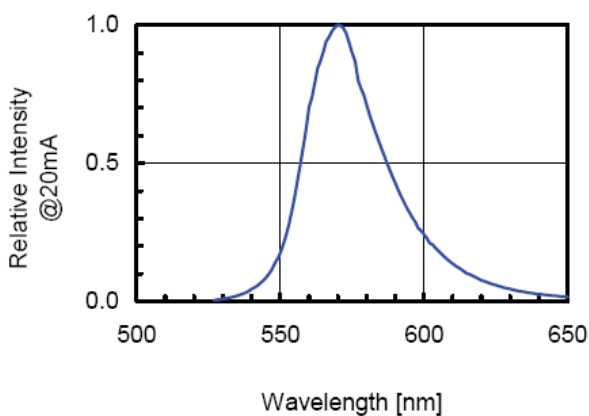

Fig 5. Relative Intensity vs. Wavelength



WCN Opto Group Co., Limited

LED Displays Reliability Test:

| CLASSIFICATION | TEST ITEM | DESCRIPTION AND TEST CONDITION |
|--------------------|--|--|
| ENDURANCE TEST | OPERATION LIFE | EVALUATES RESISTANCE OF THE DEVICE WHEN OPERATED AT ELECTRICAL STRESS T _a = UNDER ROOM TEMPERATURE I _F = I _F max |
| | HIGH TEMPERATURE HIGH HUMIDITY STORAGE | EVALUATES MOISTURE RESISTANCE OF THE DEVICE WHEN STORED FOR A LONG TERM AT HIGH TEMPERATURE AND HUMIDITY T _a = 65±5°C RH=90~95%RH TEST TIME=240± 2Hrs |
| | HIGH TEMPERATURE STORAGE | EVALUATES DEVICE DURABILITY FOR LONG TERM STORAGE IN HIGH TEMPERATURE T _a = 85±5°C(COB: T _a =65±5°C) TEST TIME=1000Hrs(-24Hrs, +72Hrs) |
| | LOW TEMPERATURE STORAGE | EVALUATES DEVICE DURABILITY FOR LONG TERM STORAGE IN LOW TEMPERATURE T _a = -35±5°C TEST TIME=1000Hrs(-24Hrs, +72Hrs) |
| ENVIRONMENTAL TEST | TEMPERATURE CYCLING | EVALUATES RESISTANCE OF DEVICE AT THERMAL STRESSES OR EXPANSION AND CONTRACTION 85°C ~ 25°C ~ -35°C ~ 25°C 30min 5min 30min 5min 10 CYCLES(COB: T _{hot} =65°C, T _{cold} =-25°C) |
| | THERMAL SHOCK | EVALUATES DEVICE STRUCTURE AND STRUCTURE AND MECHANICAL RESISTANCE WHEN SUDDENLY EXPOSED AT SERVE CHANGES 85±5°C ~ -35±5°C 10min 10min 10 CYCLES(COB: T _{hot} =65°C, T _{cold} =-25°C) |
| | SOLDERABILITY | EVALUATES SOLDERABILITY ON LEADS OF DEVICE T.SOL=230±5°C DWELL TIME=5±1sec. |
| | SOLDER RESISTANCE | EVALUATES RESISTANCE TO THERMAL STRESS CAUSED BY SOLDERING T.SOL=260±5°C DWELL TIME=10±1sec. |

Packing method A:

51 pcs / Red Expandable Polyethylene.

300 pcs / Box(360*175*130mm).

1800 pcs / Carton(550*380*280mm).

Packing method B:

10pcs / IC Tube.(520*19.5*18.5)

540 pcs / Box(537*175*125mm).

2160 pcs / Carton(550*380*280mm).