

WCN4-0056R6-A11R

SPECIFICATION

WCN			CUSTOMER Confirmed
Prepared by	Checked by	Approved by	
Fei 2016-5-10	Athena	William	
REVISION RECORD			

**REVISION: A0**

Outer Dimension:

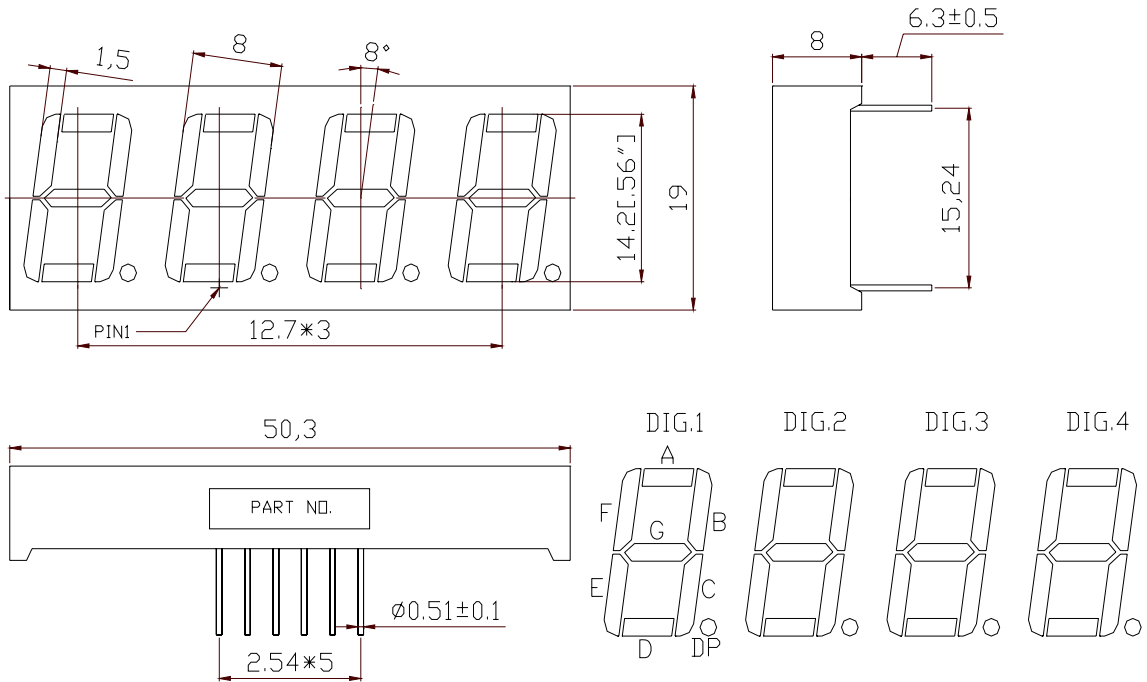

Notes: Unless otherwise stated, The tolerance is $\pm 0.25\text{mm}$.

Circuit Diagram:

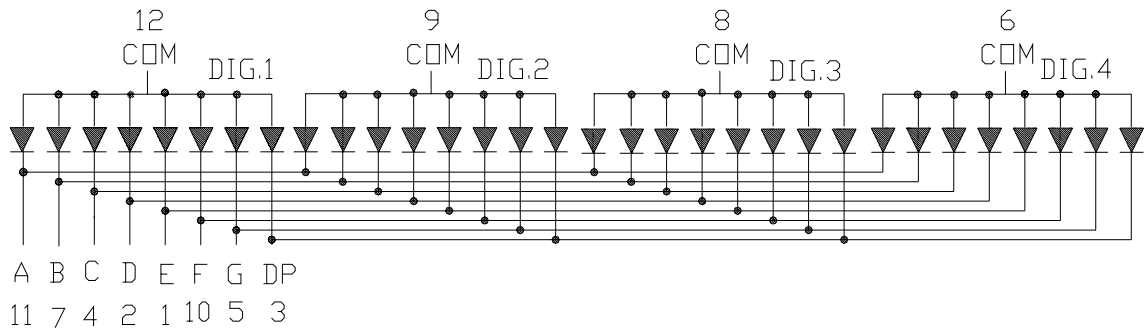

Pin Connection:

PIN NO.	CONNECTION	PIN NO.	CONNECTION
1	Cathode E	7	Cathode B
2	Cathode D	8	Common Anode Dig.3
3	Cathode Dp	9	Common Anode Dig.2
4	Cathode C	10	Cathode F
5	Cathode G	11	Cathode A
6	Common Anode Dig.4	12	Common Anode Dig.1

■ Features:

- High Reliability
- Color: Super Bright Red.
- Low Power Requirement
- Easy Assembly

■ Description:

- Four Digit Display
- Digit Height: 14.2mm(0.56")
- Black Face and Milky Segment

■ Absolute Maximum Rating (Ta=25°C):

Parameter	Symbol	Condition	Color	Rating	Units
Power Dissipation Per Segment	P _d	—	Red	65	mW
Forward Current Per Segment	I _F	—	Red	25	mA
Peak Forward Current Per Segment	I _{FP}	1/10 Duty 10KHz	Red	100	mA
Reverse Voltage Per Segment	V _R	—	Red	5	V
Operating Temperature Range	T _{opr}	—	—	-35~+85	°C
Storage Temperature Range	T _{stg}	—	—	-35~+85	°C

■ Electrical/Optical Characteristics Rating(Ta=25°C)

Item	Symbol	Test conditions	Location	Rating			Units
				Min.	Typ.	Max.	
Forward Voltage	V _F	I _F =20mA	Per Segment	—	2.00	2.60	V
Reverse Current	I _R	V _R =5V	Per Segment	—	—	100	μA
Luminous Intensity	I _v	I _F =10mA	Per Segment	7201	11500	18000	μcd
Peak Emission Wave Length	λ _P	I _F =20mA	Per Segment	—	635	—	nm
	λ _D				630		
Spectral Line Half Width	Δλ	I _F =20mA	Per Segment	—	20	—	nm
Luminous Intensity Matching Ratio (Segment to Segment)	I _{v-m}	I _F =10mA	—	—	—	1.2:1	

■ Luminous Intensity Sorting: (Luminous Intensity Tolerance is +/-10%)

Rank	Symbol	Condition	Min	Max	Unit
O	O	I _F =10mA	7201	8500	μcd
P	P	I _F =10mA	8501	10500	μcd
Q	Q	I _F =10mA	10501	12800	μcd
R	R	I _F =10mA	12801	15250	μcd
S	S	I _F =10mA	15251	18000	μcd

■ Soldering Conditions: Soldering Temp. ≤+260°C, Soldering Time. ≤3sec.
(at 2mm Distance from The Case of Reflector Edge)

■ **Typical Elector-Optical Characteristics Curve:**

Forward current vs. Forward voltage

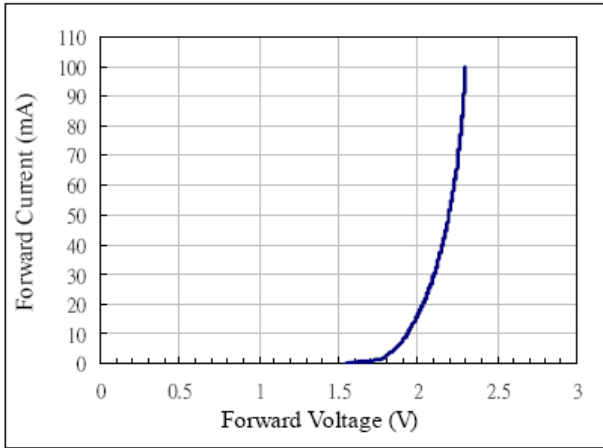

Relative intensity vs. Forward current

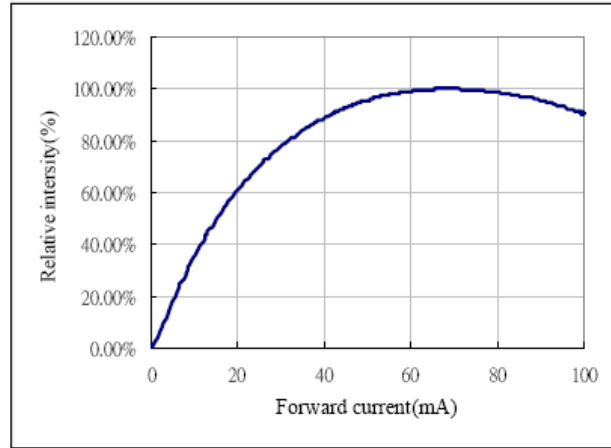

Forward voltage vs. Temperature

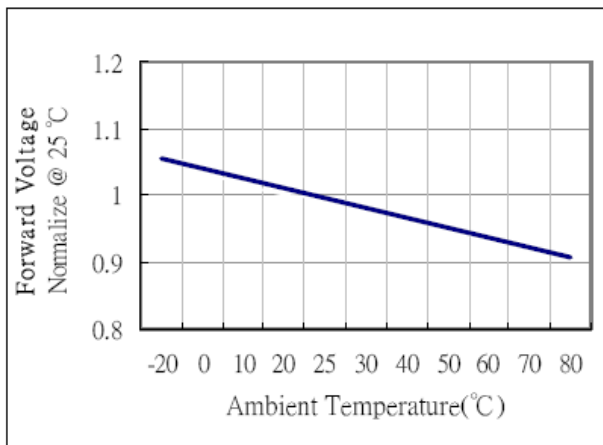

Relative intensity vs. Temperature

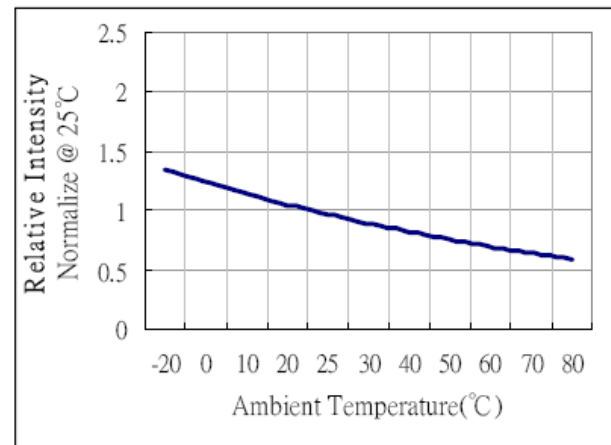

Relative intensity vs. Wavelength

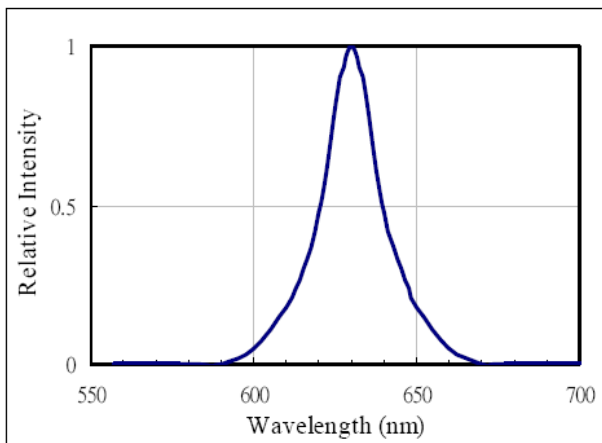

WCN Opto Group Co., Limited

■ LED Displays Reliability Test:

CLASSIFICATION	TEST ITEM	DESCRIPTION AND TEST CONDITION
ENDURANCE TEST	OPERATION LIFE	EVALUATES RESISTANCE OF THE DEVICE WHEN OPERATED AT ELECTRICAL STRESS T _a = UNDER ROOM TEMPERATURE I _F = I _F max
	HIGH TEMPERATURE HIGH HUMIDITY STORAGE	EVALUATES MOISTURE RESISTANCE OF THE DEVICE WHEN STORED FOR A LONG TERM AT HIGH TEMPERATURE AND HUMIDITY T _a = 65±5°C RH=90~95%RH TEST TIME=240± 2Hrs
	HIGH TEMPERATURE STORAGE	EVALUATES DEVICE DURABILITY FOR LONG TERM STORAGE IN HIGH TEMPERATURE T _a = 85±5°C(COB: T _a =65±5°C) TEST TIME=1000Hrs(-24Hrs, +72Hrs)
	LOW TEMPERATURE STORAGE	EVALUATES DEVICE DURABILITY FOR LONG TERM STORAGE IN LOW TEMPERATURE T _a = -35±5°C TEST TIME=1000Hrs(-24Hrs, +72Hrs)
ENVIRONMENTAL TEST	TEMPERATURE CYCLING	EVALUATES RESISTANCE OF DEVICE AT THERMAL STRESSES OR EXPANSION AND CONTRACTION 85°C ~ 25°C ~ -35°C ~ 25°C 30min 5min 30min 5min 10 CYCLES(COB: T _{hot} =65°C, T _{cold} =-25°C)
	THERMAL SHOCK	EVALUATES DEVICE STRUCTURE AND STRUCTURE AND MECHANICAL RESISTANCE WHEN SUDDENLY EXPOSED AT SERVE CHANGES 85±5°C ~ -35±5°C 10min 10min 10 CYCLES(COB: T _{hot} =65°C, T _{cold} =-25°C)
	SOLDERABILITY	EVALUATES SOLDERABILITY ON LEADS OF DEVICE T.SOL=230±5°C DWELL TIME=5±1sec.
	SOLDER RESISTANCE	EVALUATES RESISTANCE TO THERMAL STRESS CAUSED BY SOLDERING T.SOL=260±5°C DWELL TIME=10±1sec.

■ Packing method A:

51 pcs / Red Expandable Polyethylene.

300 pcs / Box(360*175*130mm).

1800 pcs / Carton(550*380*280mm).

■ Packing method B:

10pcs / IC Tube.(520*24.2*19)

420 pcs / Box(537*175*125mm).

1680 pcs / Carton(550*380*280mm).