

**WCN1-0030SD-A11****SPECIFICATION**

WCN			CUSTOMER Confirmed
Prepared by	Checked by	Approved by	
Liu 2016-1-12	Athena		
REVISION RECORD			

**REVISION: A0**

## Outer Dimension:

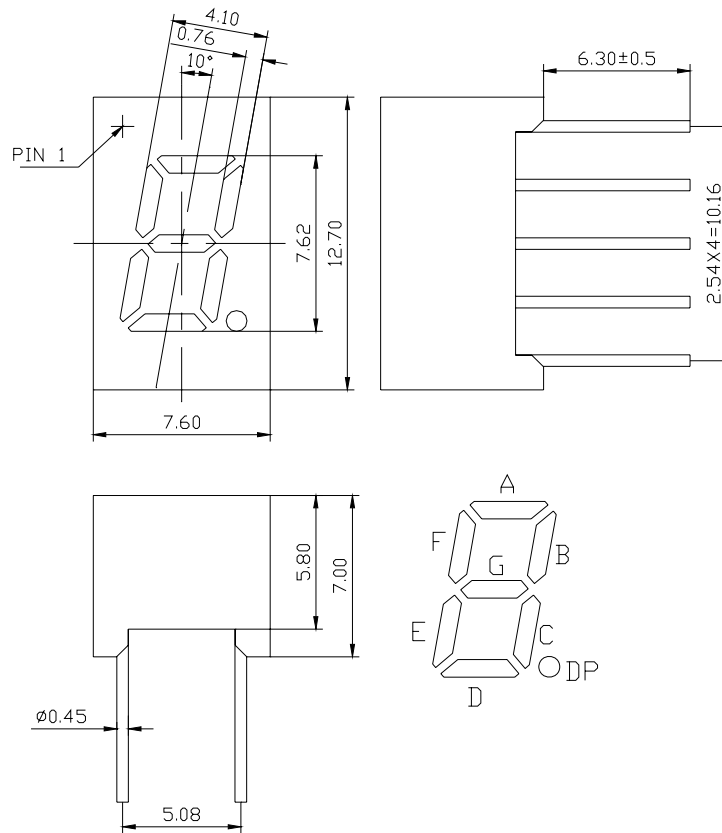

Notes: Unless otherwise stated, the tolerance is  $\pm 0.25\text{mm}$ .

## Circuit Diagram

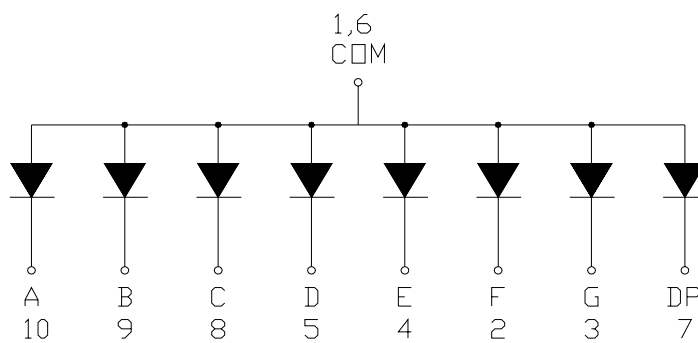

## Pin Connection:

PIN NO.	CONNECTION	PIN NO.	CONNECTION
1	Common Anode	6	Common Anode
2	Cathode F	7	Cathode DP
3	Cathode G	8	Cathode C
4	Cathode E	9	Cathode B
5	Cathode D	10	Cathode A

■ **Features:**

- High Reliability
- Color: Super Red
- Low Power Requirement
- Easy Assembly

■ **Description:**

- Single Digit LED Display
- Digit Height: 7.62mm(0.30")
- Black Face and Milky Segment

■ **Absolute Maximum Rating (Ta=25°C):**

Parameter	Symbol	Condition	Color	Rating	Units
Power Dissipation Per Segment	P <sub>d</sub>	—	Red	62.5	mW
Forward Current Per Segment	I <sub>F</sub>	—	Red	25	mA
Peak Forward Current Per Segment	I <sub>FP</sub>	1/10 Duty 10KHz	Red	100	mA
Reverse Voltage Per Segment	V <sub>R</sub>	—	Red	5	V
Operating Temperature Range	T <sub>opr</sub>	—	—	-35~+85	°C
Storage Temperature Range	T <sub>stg</sub>	—	—	-35~+85	°C

■ **Electrical/Optical Characteristics Rating(Ta=25°C)**

Item	Symbol	Test conditions	Location	Rating			Units
				Min.	Typ.	Max.	
Forward Voltage	V <sub>F</sub>	I <sub>F</sub> =20mA	Per Segment	—	2.00	2.50	V
Reverse Current	I <sub>R</sub>	V <sub>R</sub> =5V	Per Segment	—	—	100	μA
Luminous Intensity	I <sub>V</sub>	I <sub>F</sub> =10mA	Per Segment	4001	6500	—	μcd
Peak Emission Wave Length	λ <sub>P</sub>	I <sub>F</sub> =20mA	Per Segment	—	660	—	nm
	λ <sub>D</sub>				640		
Spectral Line Half Width	△λ	I <sub>F</sub> =20mA	Per Segment	—	20	—	nm
Luminous Intensity Matching Ratio (Segment to Segment)	I <sub>v-m</sub>	I <sub>F</sub> =10mA	—	—	—	2:1	

■ **Luminous Intensity Sorting: (Luminous Intensity Tolerance is +/-10%)**

Rank	Symbol	Condition	Min	Max	Unit
L	L	I <sub>F</sub> =10mA	4001	5000	μcd
M	M	I <sub>F</sub> =10mA	5001	6100	μcd
N	N	I <sub>F</sub> =10mA	6101	7200	μcd
O	O	I <sub>F</sub> =10mA	7201	8500	μcd
P	P	I <sub>F</sub> =10mA	8501	10500	μcd

■ **Soldering Conditions:** Soldering Temp. ≤+260°C, Soldering Time. ≤3sec.  
(at 2mm Distance from The Case of Reflector Edge)

■ **Typical Electro-Optical Characteristics Curve:**

**Fig1. Forward Current vs. Forward Voltage:**

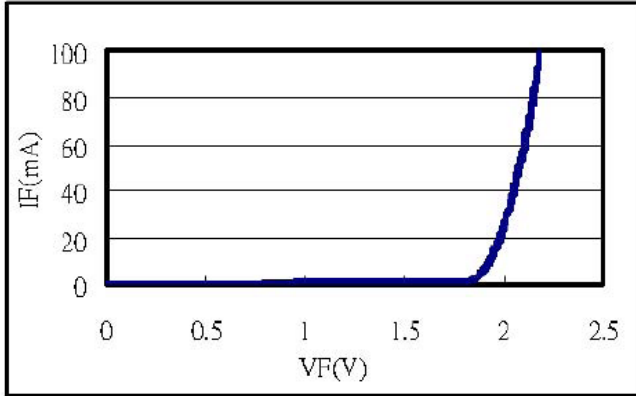

**Fig2. Forward Current vs. Relative Intensity:**

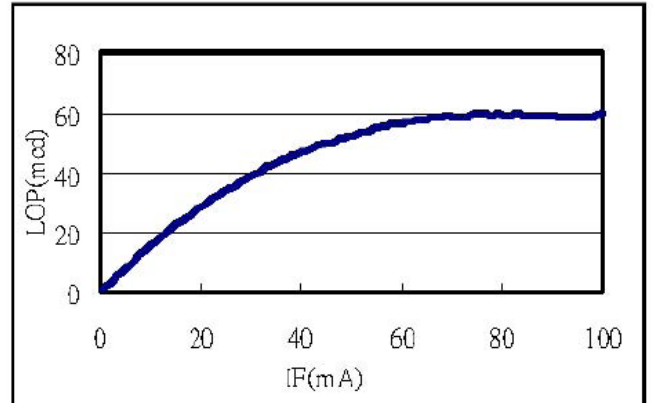

**Fig3. Forward Current vs. Relative Wavelength:**

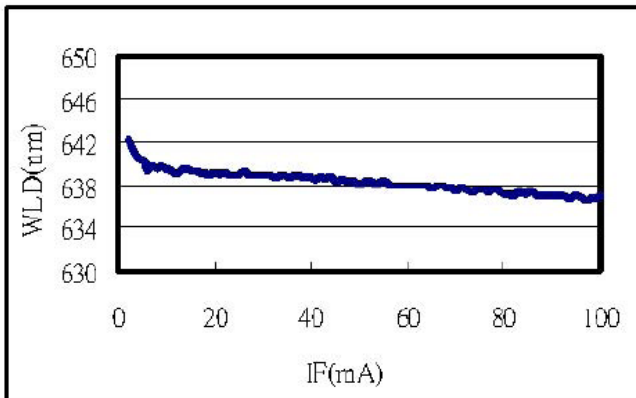

**Fig4. Temperature vs. Relative Intensity:**

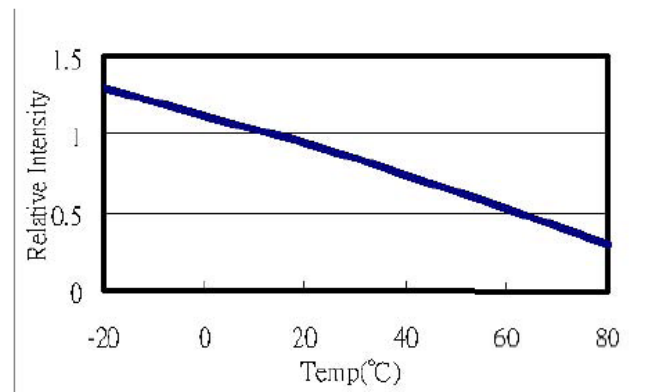

**Fig5. Temperature vs. Relative Wavelength:**

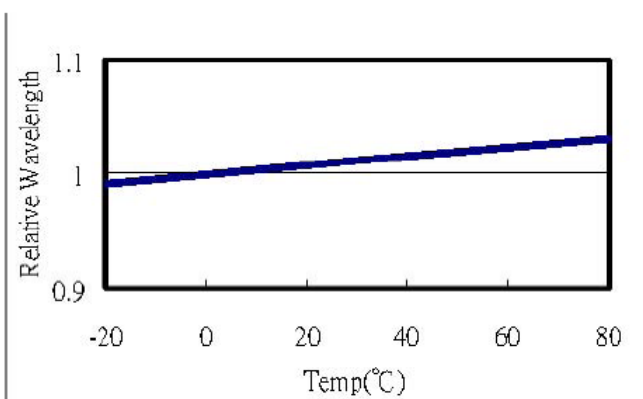

**Fig6. Life Test at 20mA R.T. 1000hrs:**

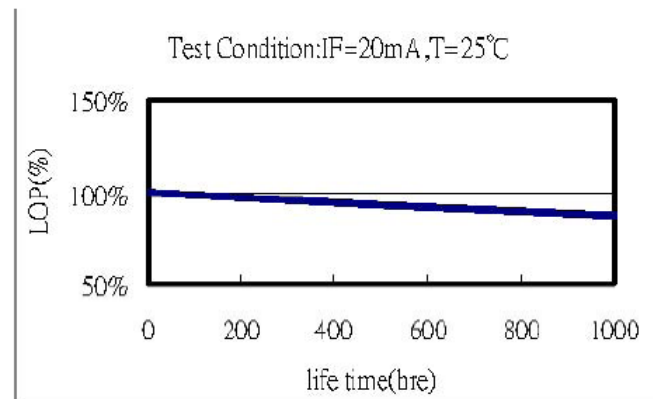

## ■ LED Displays Reliability Test:

CLASSIFICATION	TEST ITEM	DESCRIPTION AND TEST CONDITION
ENDURANCE TEST	OPERATION LIFE	EVALUATES RESISTANCE OF THE DEVICE WHEN OPERATED AT ELECTRICAL STRESS T <sub>a</sub> = UNDER ROOM TEMPERATURE I <sub>F</sub> = I <sub>F</sub> max
	HIGH TEMPERATURE HIGH HUMIDITY STORAGE	EVALUATES MOISTURE RESISTANCE OF THE DEVICE WHEN STORED FOR A LONG TERM AT HIGH TEMPERATURE AND HUMIDITY T <sub>a</sub> = 65±5°C RH=90~95%RH TEST TIME=240± 2Hrs
	HIGH TEMPERATURE STORAGE	EVALUATES DEVICE DURABILITY FOR LONG TERM STORAGE IN HIGH TEMPERATURE T <sub>a</sub> = 85±5°C(COB: T <sub>a</sub> =65±5°C) TEST TIME=1000Hrs(-24Hrs, +72Hrs)
	LOW TEMPERATURE STORAGE	EVALUATES DEVICE DURABILITY FOR LONG TERM STORAGE IN LOW TEMPERATURE T <sub>a</sub> = -35±5°C TEST TIME=1000Hrs(-24Hrs, +72Hrs)
ENVIRONMENTAL TEST	TEMPERATURE CYCLING	EVALUATES RESISTANCE OF DEVICE AT THERMAL STRESSES OR EXPANSION AND CONTRACTION 85°C ~ 25°C ~ -35°C ~ 25°C 30min 5min 30min 5min 10 CYCLES(COB: T <sub>hot</sub> =65°C, T <sub>cold</sub> =-25°C)
	THERMAL SHOCK	EVALUATES DEVICE STRUCTURE AND STRUCTURE AND MECHANICAL RESISTANCE WHEN SUDDENLY EXPOSED AT SERVE CHANGES 85±5°C ~ -35±5°C 10min 10min 10 CYCLES(COB: T <sub>hot</sub> =65°C, T <sub>cold</sub> =-25°C)
	SOLDERABILITY	EVALUATES SOLDERABILITY ON LEADS OF DEVICE T.SOL=230±5°C DWELL TIME=5±1sec.
	SOLDER RESISTANCE	EVALUATES RESISTANCE TO THERMAL STRESS CAUSED BY SOLDERING T.SOL=260±5°C DWELL TIME=10±1sec.

## ■ Package Pattern 1:

475pcs / Red Expandable Polyethylene.

2850pcs / Box(360\*175\*130mm).

17100pcs / Carton(550\*380\*280mm).

## ■ Package Pattern 2:

40pcs / IC Tube.

3600pcs / Box(537\*175\*125mm).

14400pcs / Carton(550\*380\*280mm).