

WCN1-0050GU-A11**SPECIFICATION**

WCN			CUSTOMER Confirmed
Prepared by	Checked by	Approved by	
Fei	Athena		
REVISION RECORD			

**REVISION: A0**

Outer Dimension:

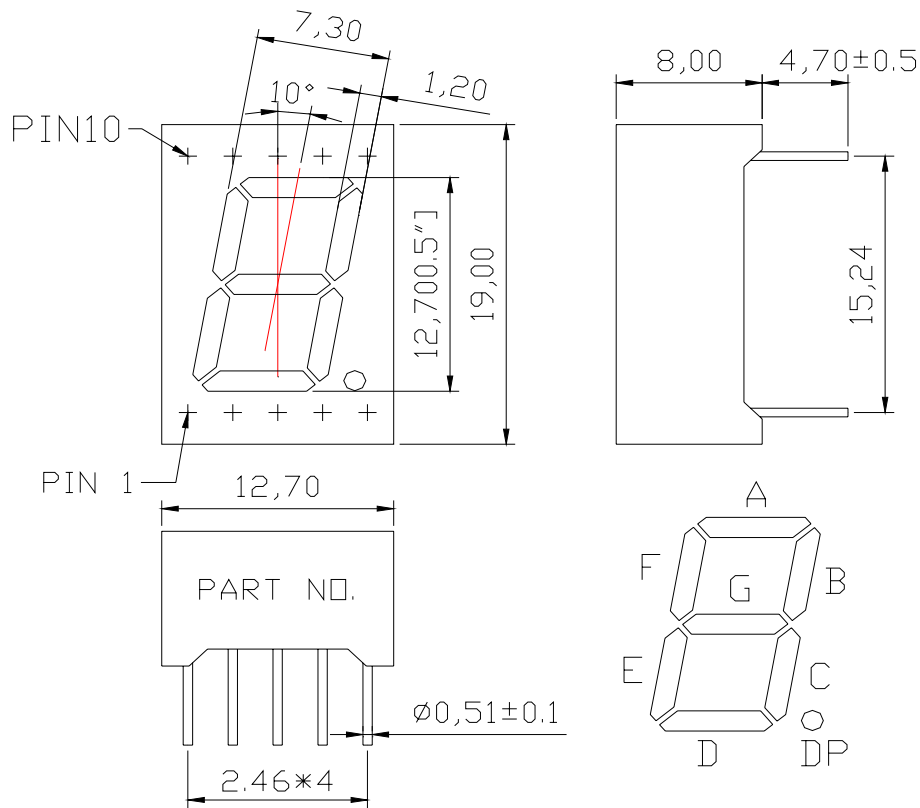

Notes: Unless otherwise stated, the tolerance is 0.25mm.

Circuit Diagram

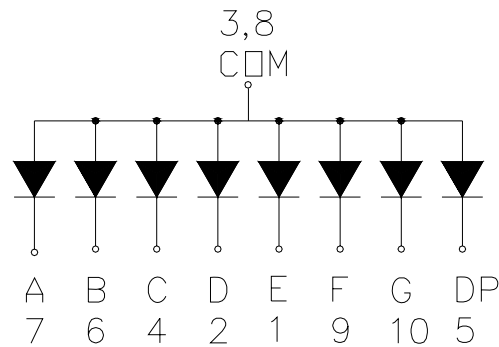

Pin Connection:

PIN NO.	CONNECTION	PIN NO.	CONNECTION
1	Cathode E	6	Cathode B
2	Cathode D	7	Cathode A
3	Common Anode	8	Common Anode
4	Cathode C	9	Cathode F
5	Cathode DP	10	Cathode G

WCN Opto Group Co., Limited

Features:

- High Reliability
- Color: Yellow Green
- Low Power Requirement
- Easy Assembly

Description:

- Single Digit LED Display
- Digit Height: 12.7mm (0.50")
- Black Face and Milky Segment

Absolute Maximum Rating (Ta=25):)

Parameter	Symbol	Condition	Color	Rating	Units
Power Dissipation Per Segment	P _d		Yellow Green	65	mW
Forward Current Per Segment	I _F		Yellow Green	25	mA
Peak Forward Current Per Segment	I _{FP}	1/10 Duty 10KHz	Yellow Green	100	mA
Reverse Voltage Per Segment	V _R		Yellow Green	5	V
Operating Temperature Range	T _{opr}			-35 +85	
Storage Temperature Range	T _{stg}			-35 +85	

Electrical/Optical Characteristics Rating(Ta=25)

Item	Symbol	Test conditions	Location	Rating			Units
				Min.	Typ.	Max.	
Forward Voltage	V _F	I _F =20mA	Per Segment		2.25	2.60	V
Reverse Current	I _R	V _R =5V	Per Segment			100	A
Luminous Intensity	I _V	I _F =10mA	Per Segment	1751	3500		cd
Peak Emission Wave Length	P	I _F =20mA	Per Segment		568		nm
	D				571		
Spectral Line Half Width		I _F =20mA	Per Segment		20		nm
Luminous Intensity Matching Ratio (Segment to Segment)	I _{v-m}	I _F =10mA				1.2:1	

Luminous Intensity Sorting: (Luminous Intensity Tolerance is +/-10%)

Rank	Symbol	Condition	Min	Max	Unit
I	I	I _F =10mA	1751	2350	cd
J	J	I _F =10mA	2351	3050	cd
K	K	I _F =10mA	3051	4000	cd
L	L	I _F =10mA	4001	5000	cd
M	M	I _F =10mA	5001	6100	cd

Hue Grade: I_F =10mA (Hue:+/-1nm)

Rank	Symbol	Hue Range	Units
3	3	569.1~571.0	nm
4	4	571.1~573.0	nm

Soldering Conditions: Soldering Temp. +260 , Soldering Time. 3sec.

(at 2mm Distance from The Case of Reflector Edge)

Typical Electro-Optical Characteristics Curve:

Fig 1. Forward Current vs. Forward Voltage

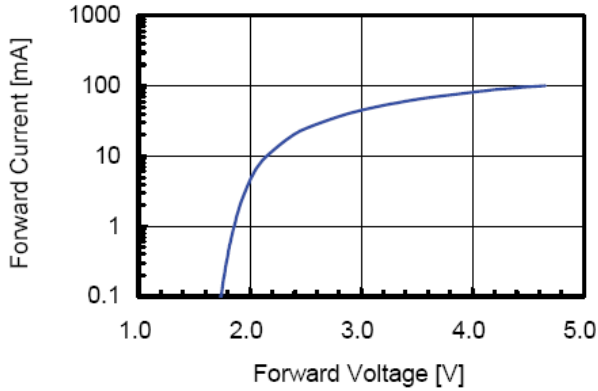

Fig 2. Relative Intensity vs. Forward Current

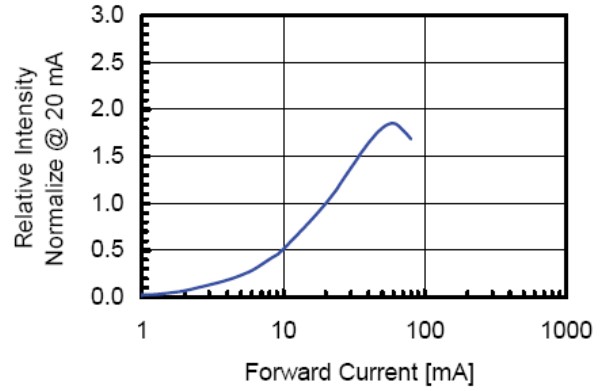

Fig 3. Forward Voltage vs. Temperature

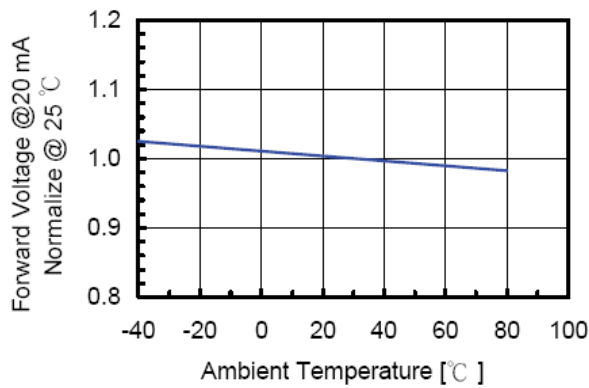

Fig 4. Relative Intensity vs. Temperature

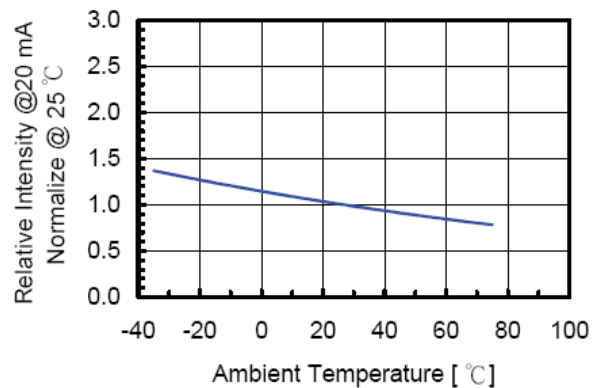
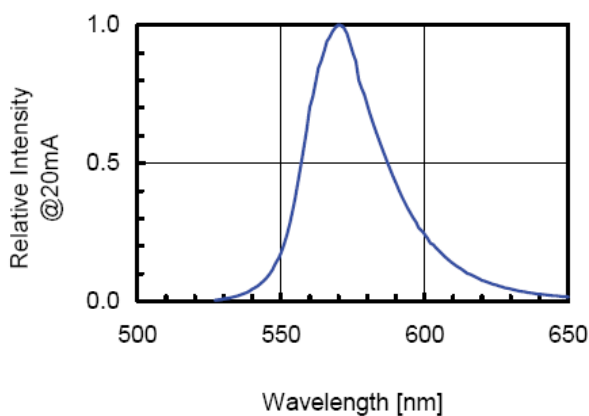

Fig 5. Relative Intensity vs. Wavelength



WCN Opto Group Co., Limited

LED Displays Reliability Test:

CLASSIFICATION	TEST ITEM	DESCRIPTION AND TEST CONDITION
ENDURANCE TEST	OPERATION LIFE	EVALUATES RESISTANCE OF THE DEVICE WHEN OPERATED AT ELECTRICAL STRESS T _a = UNDER ROOM TEMPERATURE I _F = I _F max
	HIGH TEMPERATURE HIGH HUMIDITY STORAGE	EVALUATES MOISTURE RESISTANCE OF THE DEVICE WHEN STORED FOR A LONG TERM AT HIGH TEMPERATURE AND HUMIDITY T _a = 65±5°C RH=90~95%RH TEST TIME=240± 2Hrs
	HIGH TEMPERATURE STORAGE	EVALUATES DEVICE DURABILITY FOR LONG TERM STORAGE IN HIGH TEMPERATURE T _a = 85±5°C(COB: T _a =65±5°C) TEST TIME=1000Hrs(-24Hrs, +72Hrs)
	LOW TEMPERATURE STORAGE	EVALUATES DEVICE DURABILITY FOR LONG TERM STORAGE IN LOW TEMPERATURE T _a = -35±5°C TEST TIME=1000Hrs(-24Hrs, +72Hrs)
ENVIRONMENTAL TEST	TEMPERATURE CYCLING	EVALUATES RESISTANCE OF DEVICE AT THERMAL STRESSES OR EXPANSION AND CONTRACTION 85°C ~ 25°C ~ -35°C ~ 25°C 30min 5min 30min 5min 10 CYCLES(COB: T _{hot} =65°C, T _{cold} =-25°C)
	THERMAL SHOCK	EVALUATES DEVICE STRUCTURE AND STRUCTURE AND MECHANICAL RESISTANCE WHEN SUDDENLY EXPOSED AT SERVE CHANGES 85±5°C ~ -35±5°C 10min 10min 10 CYCLES(COB: T _{hot} =65°C, T _{cold} =-25°C)
	SOLDERABILITY	EVALUATES SOLDERABILITY ON LEADS OF DEVICE T.SOL=230±5°C DWELL TIME=5±1sec.
	SOLDER RESISTANCE	EVALUATES RESISTANCE TO THERMAL STRESS CAUSED BY SOLDERING T.SOL=260±5°C DWELL TIME=10±1sec.

Package Pattern 1:

175pcs / Red Expandable Polyethylene.

1050pcs / Box(360*175*130mm).

6300pcs / Carton(550*380*280mm).

Package Pattern 2:

40pcs / IC Tube.

1680pcs / Box(537*175*125mm).

6720pcs / Carton(550*380*280mm).