

**WCN1-00A0R6-C21****SPECIFICATION**

WCN			CUSTOMER Confirmed
Prepared by	Checked by	Approved by	
Fei	Athena	William	
REVISION RECORD			

**REVISION: A1**

### Outer Dimension:

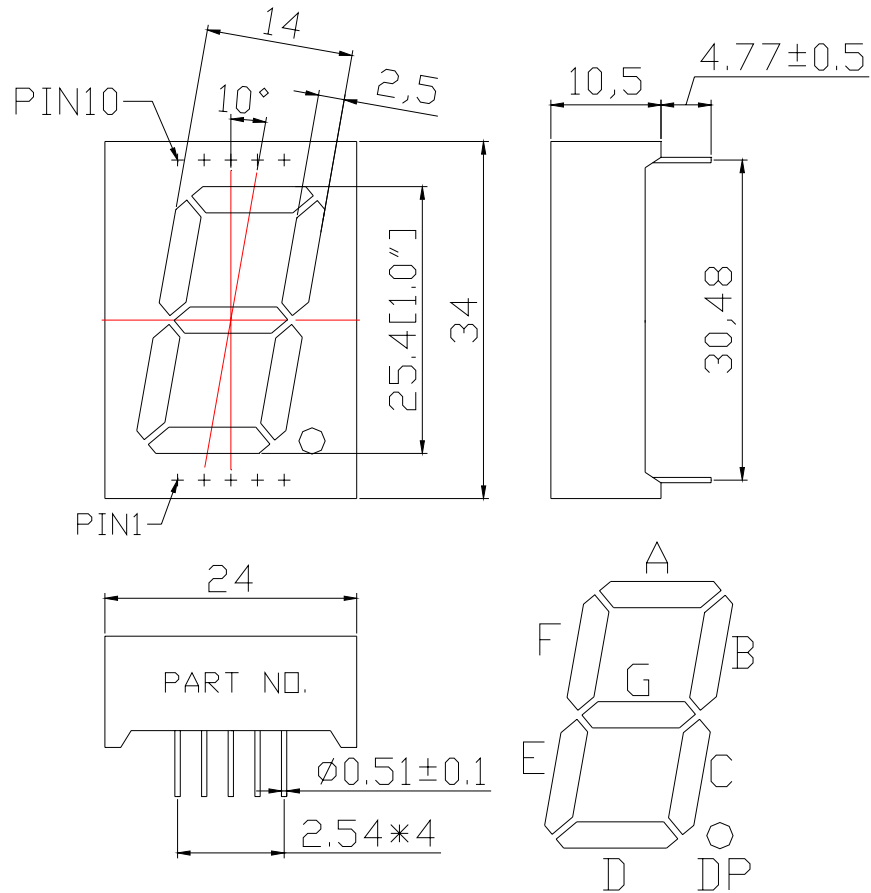

Notes: Unless otherwise stated, the tolerance is  $\pm 0.25$ mm.

### Circuit Diagram

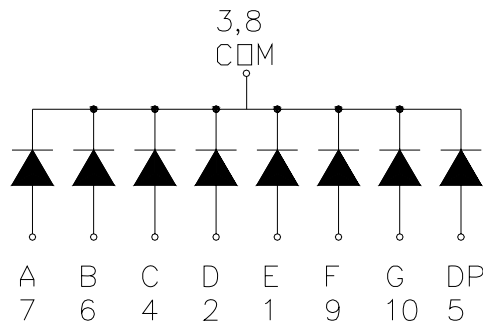

### Pin Connection

PIN NO.	CONNECTION	PIN NO.	CONNECTION
1	Anode E	6	Anode e B
2	Anode D	7	Anode A
3	Common Cathode	8	Common Cathode
4	Anode C	9	Anode F
5	Anode DP	10	Anode G

■ **Features:**

- High Reliability
- Color: Super Bright Red
- Low Power Requirement
- Easy Assembly

■ **Description:**

- Single Digit LED Display
- Digit Height: 25.4mm (1.0")
- Black Face and Milky Segment

■ **Absolute Maximum Rating (Ta=25°C):**

Parameter	Symbol	Condition	Color	Rating	Units
Power Dissipation Per Segment	P <sub>d</sub>	—	Red	62.5	mW
Forward Current Per Segment	I <sub>F</sub>	—	Red	25	mA
Peak Forward Current Per Segment	I <sub>FP</sub>	1/10 Duty 10KHz	Red	100	mA
Reverse Voltage Per Segment	V <sub>R</sub>	—	Red	5	V
Operating Temperature Range	T <sub>opr</sub>	—	—	-35~+85	°C
Storage Temperature Range	T <sub>stg</sub>	—	—	-35~+85	°C

■ **Electrical/Optical Characteristics Rating(Ta=25°C)**

Item	Symbol	Test conditions	Location	Rating			Units
				Min.	Typ.	Max.	
Forward Voltage	V <sub>F</sub>	I <sub>F</sub> =20mA	Per Segment	—	2.00	2.50	V
Reverse Current	I <sub>R</sub>	V <sub>R</sub> =5V	Per Segment	—	—	100	μA
Luminous Intensity	I <sub>V</sub>	I <sub>F</sub> =10mA	Per Segment	8001	16600	—	μcd
Peak Emission Wave Length	λ <sub>P</sub>	I <sub>F</sub> =20mA	Per Segment	—	635	—	nm
	λ <sub>D</sub>				630		
Spectral Line Half Width	Δλ	I <sub>F</sub> =20mA	Per Segment	—	20	—	nm
Luminous Intensity Matching Ratio (Segment to Segment)	I <sub>v-m</sub>	I <sub>F</sub> =10mA	—	—	—	1.2:1	

■ **Luminous Intensity Sorting: (Luminous Intensity Tolerance is +/-10%)**

Rank	Symbol	Condition	Min	Max	Unit
L	L	I <sub>F</sub> =10mA	8001	12560	μcd
M	M	I <sub>F</sub> =10mA	12561	20000	μcd
N	N	I <sub>F</sub> =10mA	20001	32000	μcd

■ **Soldering Conditions: Soldering Temp. ≤ +260°C, Soldering Time. ≤ 3sec.**  
 (at 2mm Distance from The Case of Reflector Edge)

■ **Typical Electro-Optical Characteristics Curve:**

Forward current vs. Forward voltage

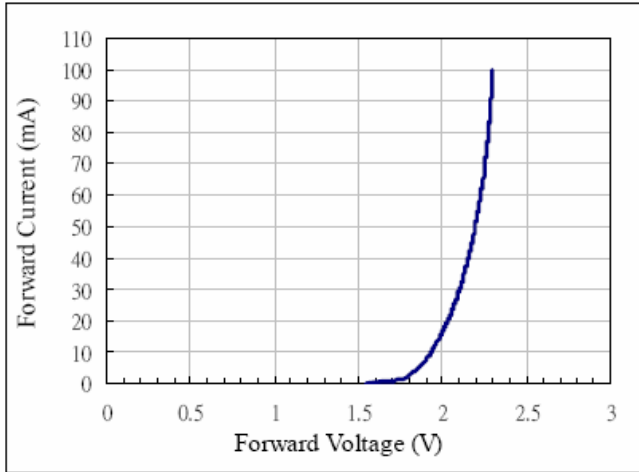

Relative intensity vs. Forward current

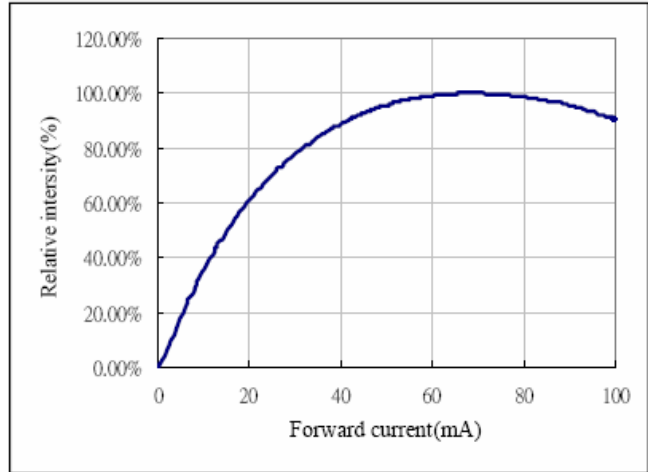

Forward voltage vs. Temperature

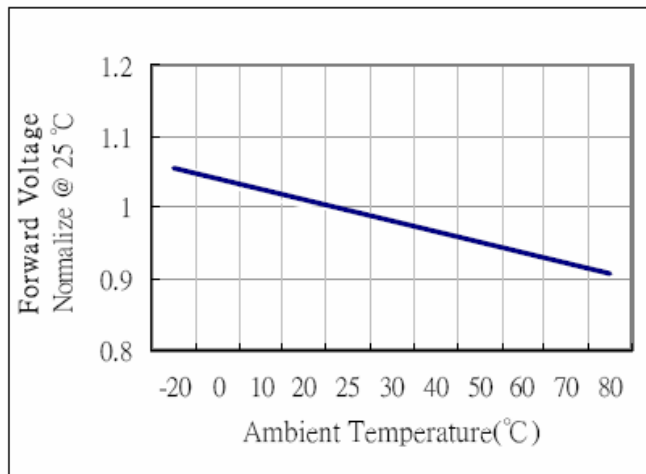

Relative intensity vs. Temperature

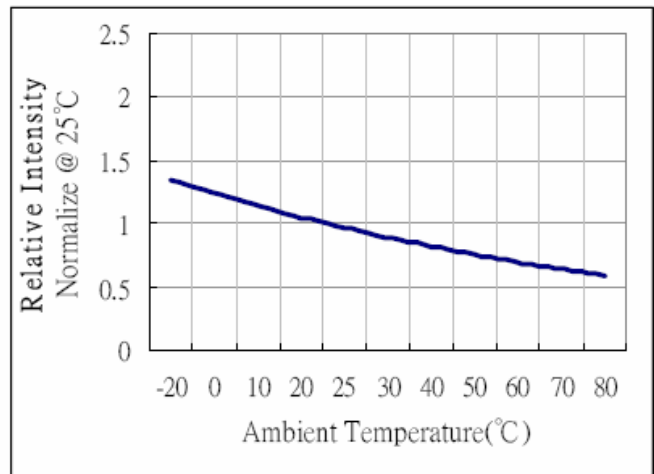

Relative intensity vs. Wavelength

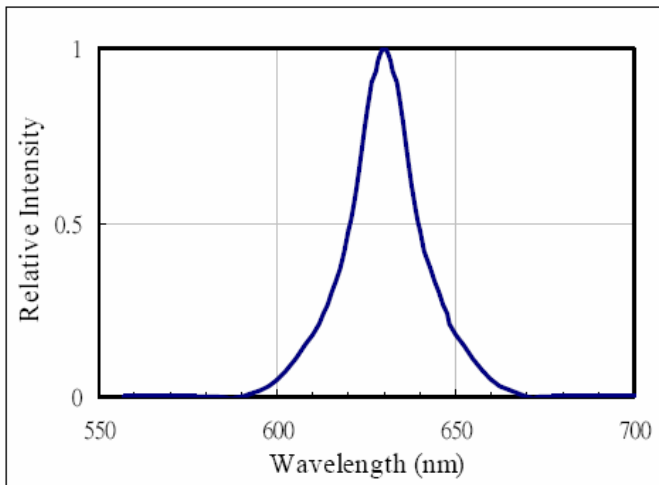

# WCN Opto Group Co., Limited

## ■ LED Displays Reliability Test:

CLASSIFICATION	TEST ITEM	DESCRIPTION AND TEST CONDITION
ENDURANCE TEST	OPERATION LIFE	EVALUATES RESISTANCE OF THE DEVICE WHEN OPERATED AT ELECTRICAL STRESS $T_a$ = UNDER ROOM TEMPERATURE $I_F = I_{F \text{ max}}$
	HIGH TEMPERATURE HIGH HUMIDITY STORAGE	EVALUATES MOISTURE RESISTANCE OF THE DEVICE WHEN STORED FOR A LONG TERM AT HIGH TEMPERATURE AND HUMIDITY $T_a = 65 \pm 5^\circ\text{C}$ RH=90~95%RH TEST TIME=240± 2Hrs
	HIGH TEMPERATURE STORAGE	EVALUATES DEVICE DURABILITY FOR LONG TERM STORAGE IN HIGH TEMPERATURE $T_a = 85 \pm 5^\circ\text{C}$ (COB: $T_a = 65 \pm 5^\circ\text{C}$ ) TEST TIME=1000Hrs(-24Hrs, +72Hrs)
	LOW TEMPERATURE STORAGE	EVALUATES DEVICE DURABILITY FOR LONG TERM STORAGE IN LOW TEMPERATURE $T_a = -35 \pm 5^\circ\text{C}$ TEST TIME=1000Hrs(-24Hrs, +72Hrs)
ENVIRONMENTAL TEST	TEMPERATURE CYCLING	EVALUATES RESISTANCE OF DEVICE AT THERMAL STRESSES OR EXPANSION AND CONTRACTION $85^\circ\text{C} \sim 25^\circ\text{C} \sim -35^\circ\text{C} \sim 25^\circ\text{C}$ 30min 5min 30min 5min 10 CYCLES(COB: $T_{\text{hot}}=65^\circ\text{C}$ , $T_{\text{cold}}=-25^\circ\text{C}$ )
	THERMAL SHOCK	EVALUATES DEVICE STRUCTURE AND STRUCTURE AND MECHANICAL RESISTANCE WHEN SUDDENLY EXPOSED AT SERVE CHANGES $85 \pm 5^\circ\text{C} \sim -35 \pm 5^\circ\text{C}$ 10min 10min 10 CYCLES(COB: $T_{\text{hot}}=65^\circ\text{C}$ , $T_{\text{cold}}=-25^\circ\text{C}$ )
	SOLDERABILITY	EVALUATES SOLDERABILITY ON LEADS OF DEVICE $T_{\text{SOL}}=230 \pm 5^\circ\text{C}$ DWELL TIME=5±1sec.
	SOLDER RESISTANCE	EVALUATES RESISTANCE TO THERMAL STRESS CAUSED BY SOLDERING $T_{\text{SOL}}=260 \pm 5^\circ\text{C}$ DWELL TIME=10±1sec.

## ■ Package method 1:

54 pcs / Red Expandable Polyethylene.

270 pcs / Box(360\*175\*130mm).

1620 pcs / Catton(550\*380\*280mm).

## ■ Package method 2:

21 pcs / IC Tube.

504pcs / Box(537\*175\*125mm).

2016 pcs / Catton(550\*380\*280mm).