

WCN Opto Group Co., Limited

Customer Name:

Date:

2019-2-26

Part No:

WCN2S-1020WW-C1

Product Group Description:

LED Display

Customer Part No:

Approval Date:

Customer Confirmation

Approved by

Checked by

Athena
2019-2-26

Prepared By

Fei
2019-2-26



Country of Origin: China

World Components Network Service Ltd

5th Floor,Block A-2,Xuxingda Ind Zone
Shiyan Town,Bao An District , Shenzhen
Tel : (86)755-2900022
Fax : (86)755-2900023



www . wcnopto.net

Table of Contents

NO.	ITEM	PAGE
1	Cover	1
2	Table of Contents	2
3	Revision Record	3
4	Description	4
5	Outer Dimension and Circuit Diagram	5
6	Absolute Maximum Rating and Electrical/Optical Characteristics Rating	6
7	Typical Electrical/ Optical Characteristic Curves and Spectrometer	7
8	Packaging Data	8
9	Moisture Proof Packaging	9

WCN Opto Group Co., Limited**REVISION RECORD**

MARKER	Matter for revision	SHEET	DTAE	MAKER	APPOVED SIGN	
	Reason for revision					
A0	P# WCN2S-1020WW-C1	Whole Spec	2019-2-26	Zhang	Athena	
	New Version issued					

1. Type No./Manufacture's Name

WCN2S-1020WW-C1 / WCN Opto Group Co., Limited.

2. Features:

- High Reliability
- Low Power Requirement
- Easy Assembly

3. Faction: Display Digit Characteristic**4. Soldering Conditions: Soldering Temp. 260 ± 5 °C, Soldering Time. 3~5 sec.**

Soldering Power <30 W.

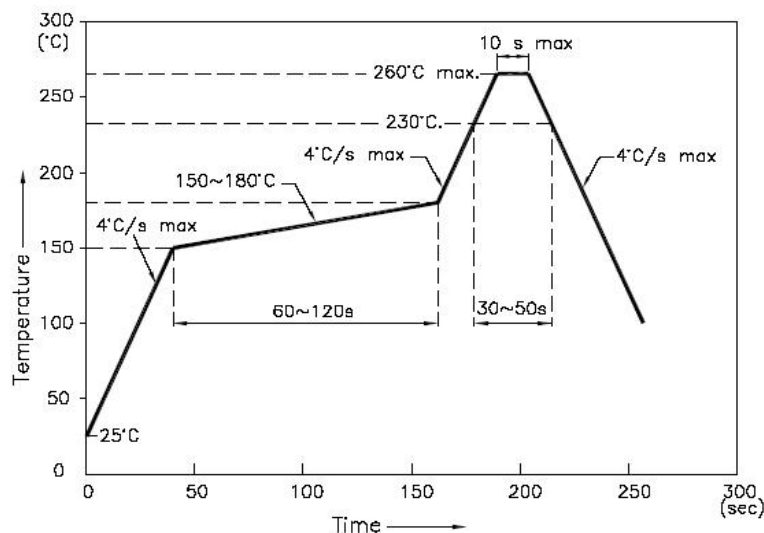
5. Re-flow Temp/Time**NOTES:**

5.1. We recommend the re-flow temperature $245^{\circ}\text{C}(\pm 5^{\circ}\text{C})$. the maximum soldering temperature should be limited to 260°C .

5.2. Don't cause stress to the epoxy resin while it is exposed to high temperature. Number of re-flow process shall be 2 times or less.

6. Description:

- Dual Digit LED Display
- Digit Height: 5.08mm(0.20")
- Gray Face and Milky Segment
- Color: White

WCN Opto Group Co., Limited

Outer Dimension:

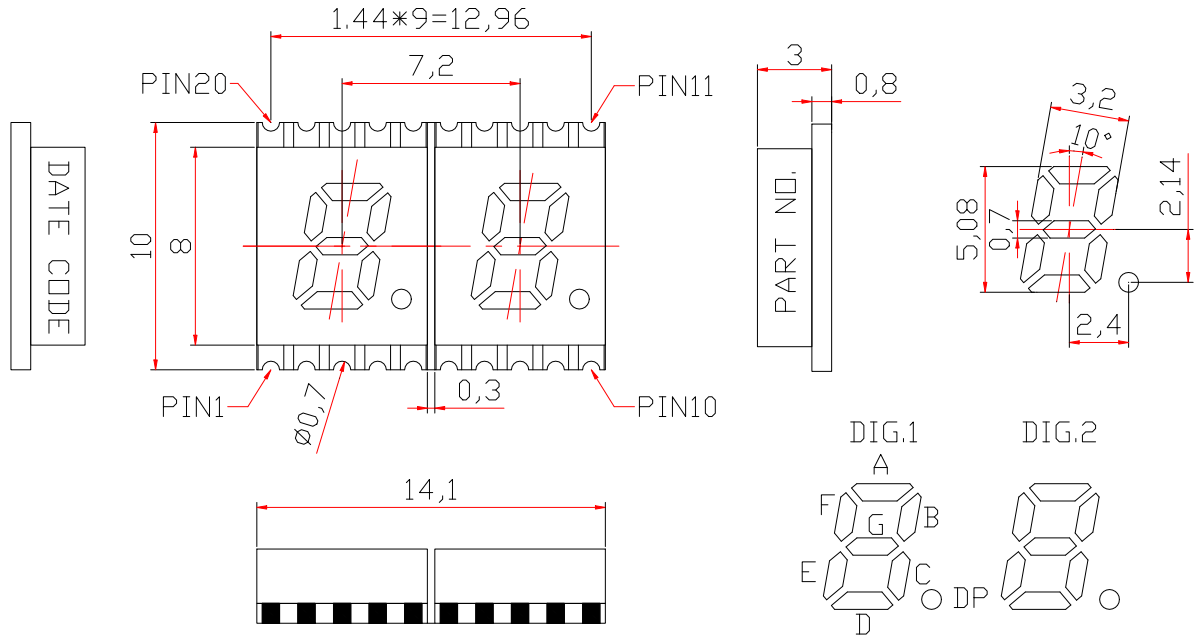

Notes: Unless otherwise stated, the tolerance is ± 0.25 mm.

Circuit Diagram:

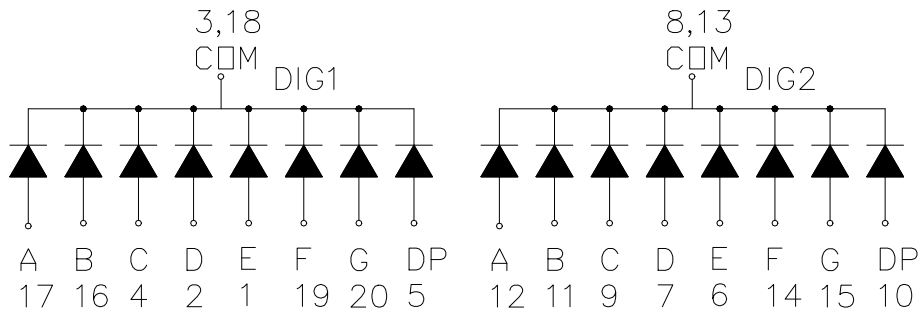

Pin Connection:

PIN NO.	CONNECTION	PIN NO.	CONNECTION
1	Anode E1	11	Anode B2
2	Anode D1	12	Anode A2
3	Common Cathode dig1	13	Common Cathode dig2
4	Anode C1	14	Anode F2
5	Anode DP1	15	Anode G2
6	Anode E2	16	Anode B1
7	Anode D2	17	Anode A1
8	Common Cathode dig2	18	Common Cathode dig1
9	Anode C2	19	Anode F1
10	Anode dp2	20	Anode G1

WCN Opto Group Co., Limited

■ ABSOLUTE MAXIMUM RATINGS AT TA=25°C

Parameter	Symbol	Condition	Color	Rating	Units
Power Dissipation Per Segment	P_d	—	White	92.5	mW
Forward Current Per Segment	I_F	—	White	25	mA
Peak Forward Current Per Segment	I_{FP}	1/10 Duty 1KHz	White	100	mA
Reverse Voltage Per Segment	V_R	—	White	5	V
Operating Temperature Range	Topr	—	—	-40~+105	°C
Storage Temperature Range	Tstg	—	—	-40~+105	°C

■ Electrical/Optical Characteristics Rating(Ta=25°C)

Item	Symbol	Test conditions	Location	Rating			Units
				Min.	Typ.	Max.	
Forward Voltage	V_F	$I_F=20mA$	Per Chip	2.6	3.3	3.7	V
Reverse Current	I_R	$V_R=5V$	Per Chip	—	—	100	μA
Luminous Intensity	I_V	$I_F=10mA$	Per Chip	37	47	58	mcd
CIE Coordinate	X	$I_F=20mA$	Per Chip	—	0.27	—	nm
	Y			—	0.28	—	
Luminous Intensity Matching Ratio (Segment To Segment)	I_{v-m}	$I_F=10mA$				1.2:1	

■ Luminous Intensity Sorting: (Luminous intensity tolerance :+/-10%)

Rank	Symbol	Condition	Min	Max	Unit
X	X	$I_F=10mA$	37	43	mcd
Y	Y	$I_F=10mA$	43	50.0	mcd
Z	Z	$I_F=10mA$	50	58.0	mcd

■ **Typical Optical-Electronic Characteristic Curves**

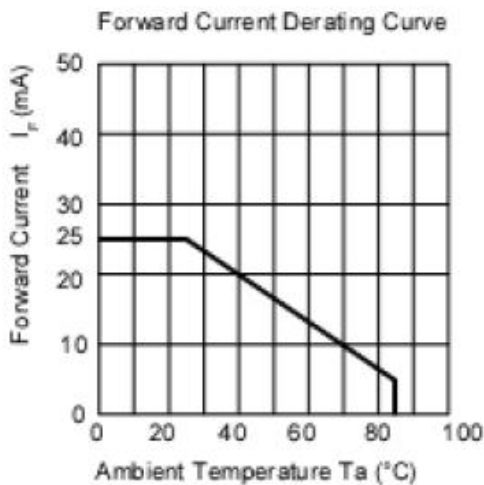
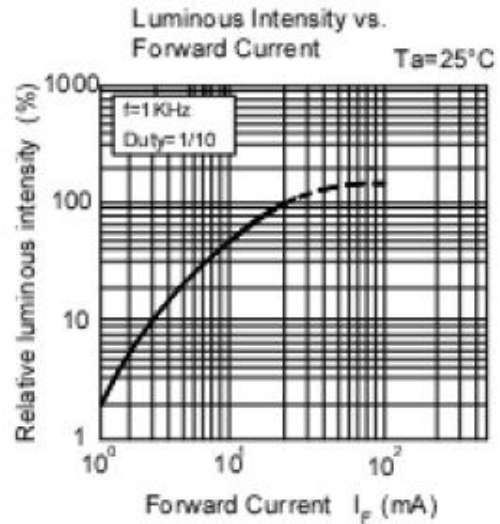
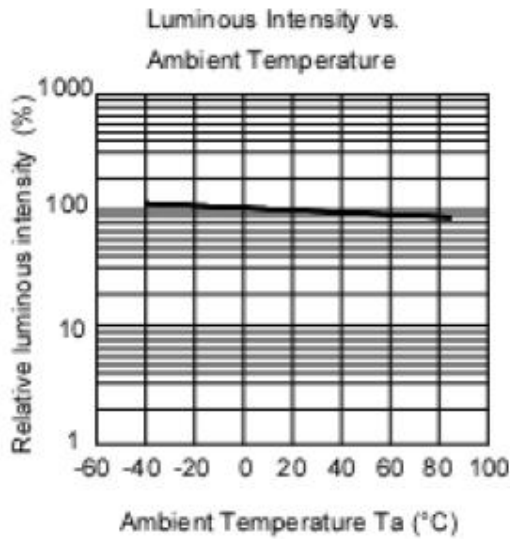
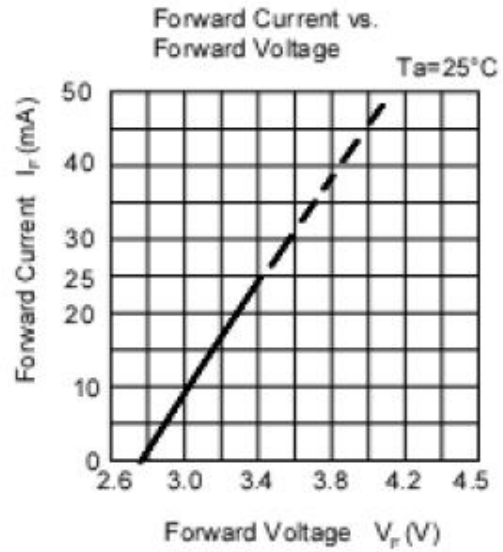
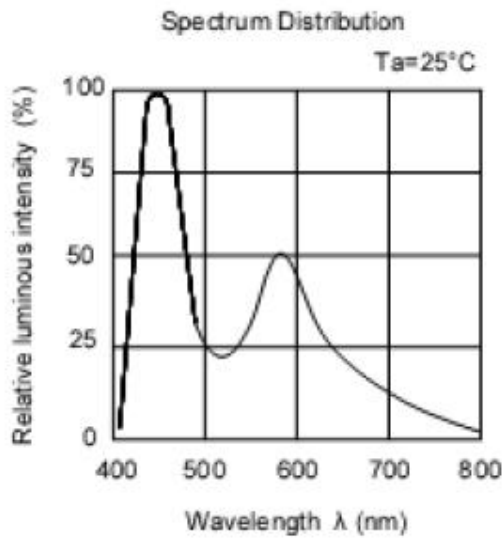

■ Packing Reel Dimensions(mm):

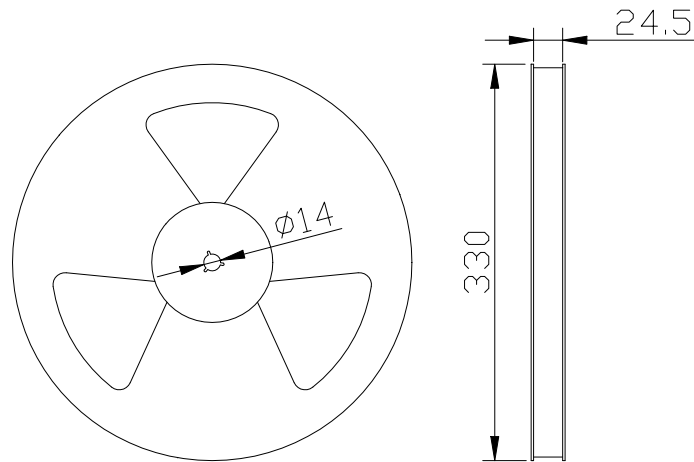

■ Dimensions of Tape (Unit: mm)

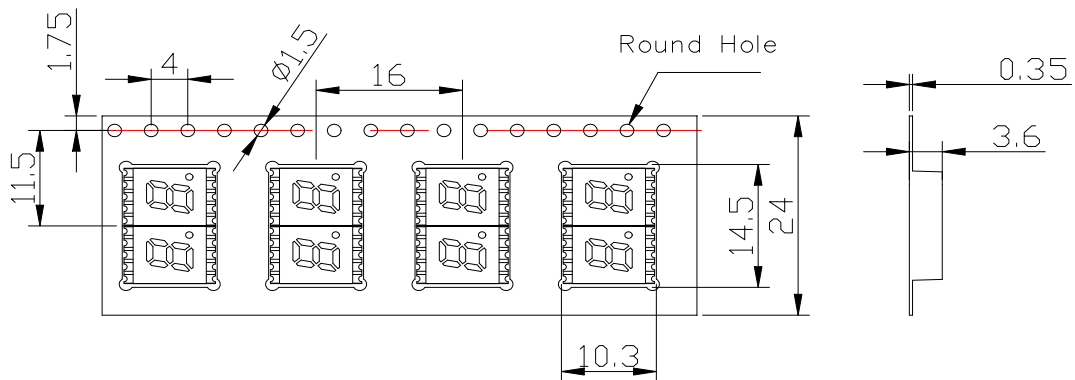

■ One Reel contained 1100 PCS products:

■ Recommended Soldering Pattern:

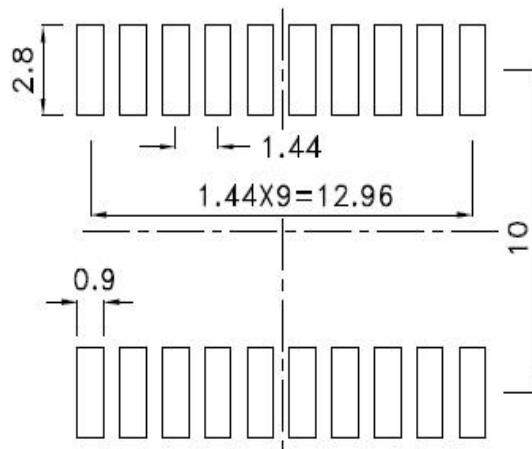

■ **Moisture Proof Packaging:**

All N/D SMD displays are shipped in moisture proof package. The displays should be stored at 30°C or less and 60% RH or less. Once the package opened, moisture absorption begins.

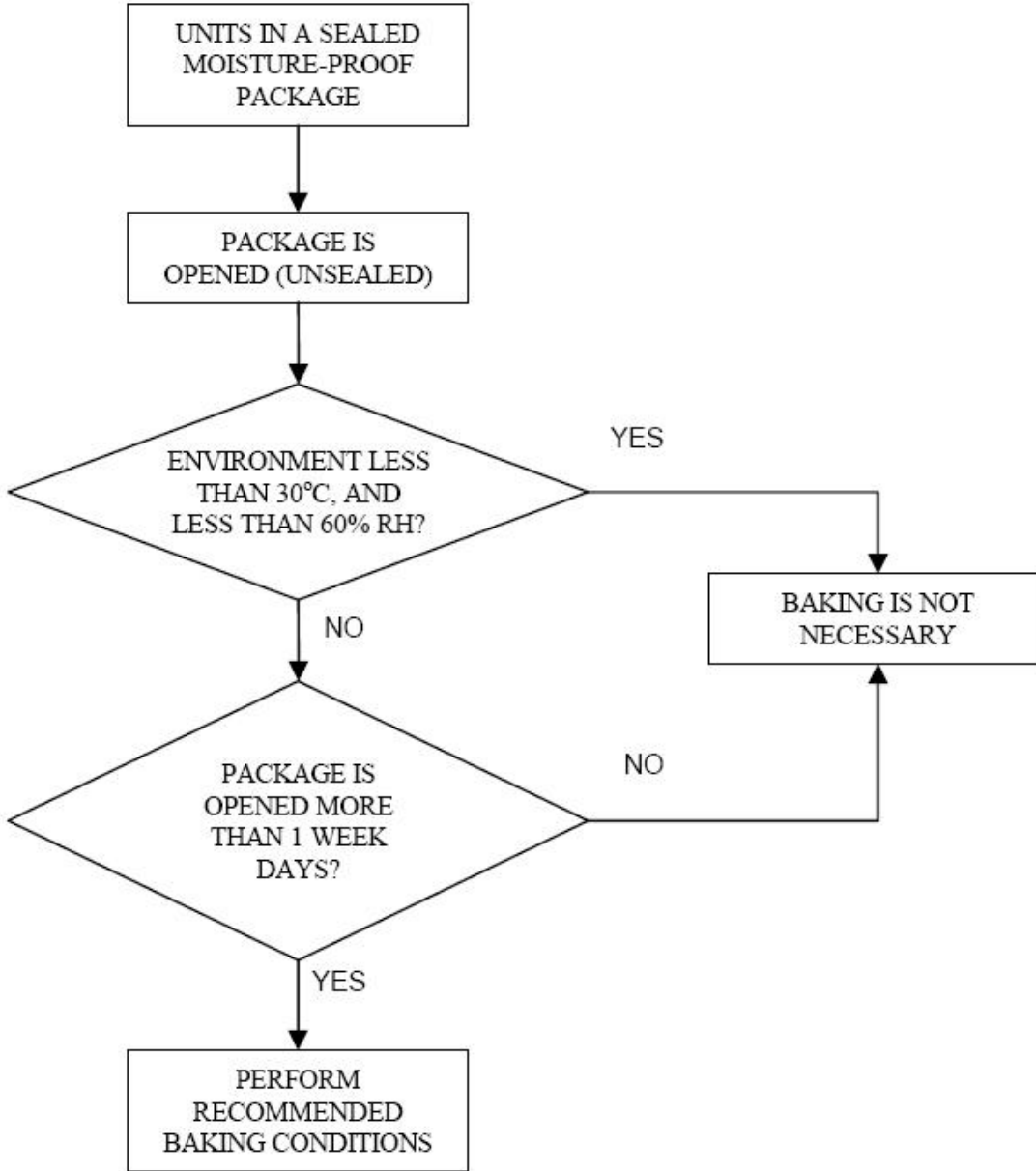

■ **Baking Conditions:**

If the parts not stored in dry conditions, they must be baked before re-flow to prevent damage to the parts.

Package	Temperature	Time
In Reel	60 °C	≥ 48hours
In Bulk	100 °C	≥ 4hours
	125 °C	≥ 2hours

■ **Baking should only be done once.**