

World Components Network Service Ltd**Customer Name:****Date:****2016-2-23****Part No:****WCN3S-1039HY-A3****Product Group
Description:****LED Display****Customer Part No:****Approval Date:****Customer
Confirmation****Approved by****Checked by****Athena
2016-2-23****Prepared By****Fei
2016-2-23****Country of Origin: China****World Components Network Service Ltd****5th Floor,Block A-2,Xuxingda Ind Zone
Shiyan Town,Bao An District , Shenzhen
Tel : (86)755-29000022
Fax : (86)755-29000023****www . wcnopto.net**

Table of Contents

NO.	ITEM	PAGE
1	Cover	1
2	Table of Contents	2
3	Revision Record	3
4	Description	4
5	Outer Dimension and Circuit Diagram	5
6	Absolute Maximum Rating and Electrical/Optical Characteristics Rating	6
7	Typical Electrical/ Optical Characteristic Curves and Spectrometer	7
8	Packaging Data	8
9	Moisture Proof Packaging	9

World Components Network Service Ltd

REVISION RECORD

MARKER	Matter for revision	SHEET	DTAE	MAKER	APPOVED SIGN	
	Reason for revision					
A0	P# WCN3S-1039HY-A3 <hr style="border-top: 1px dashed black;"/> New Version issued	Whole Spec	2016-2- 23	Fei	Athena	

1. Type No./Manufacture's Name

WCN3S-1039HY-A3 / World Components Network Service Ltd.

2. Features:

- High Reliability
- Low Power Requirement
- Easy Assembly

3. Faction: Display Digit Characteristic**4. Soldering Conditions: Soldering Temp. 260 ± 5 °C, Soldering Time. 3~5 sec.**

Soldering Power <30 W.

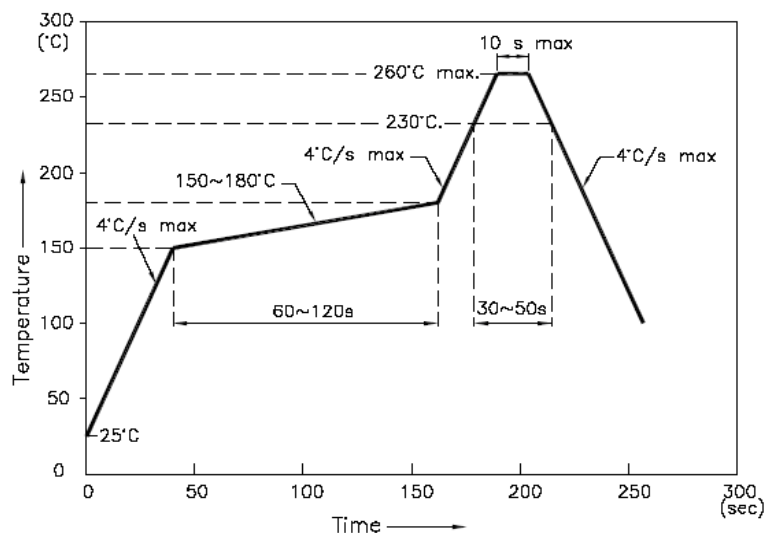
5. Re-flow Temp/Time**NOTES:**

5.1. We recommend the re-flow temperature $245^{\circ}\text{C} (\pm 5^{\circ}\text{C})$. the maximum soldering temperature should be limited to 260°C .

5.2. Don't cause stress to the epoxy resin while it is exposed to high temperature. Number of re-flow process shall be 2 times or less.

6. Description:

- Three Digit LED Display
- Digit Height: 10.0mm (0.39")
- Gray Face and Milky Segment
- Color: Yellow

Outer Dimension:

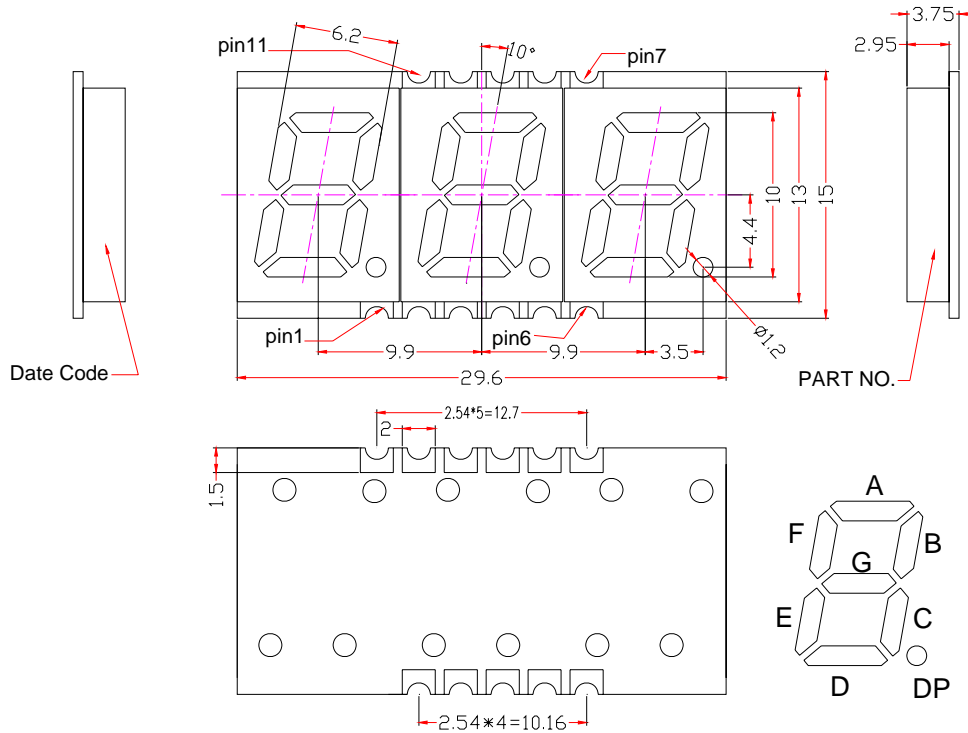

Notes: Unless otherwise stated, the tolerance is ± 0.25 mm.

Circuit Diagram:

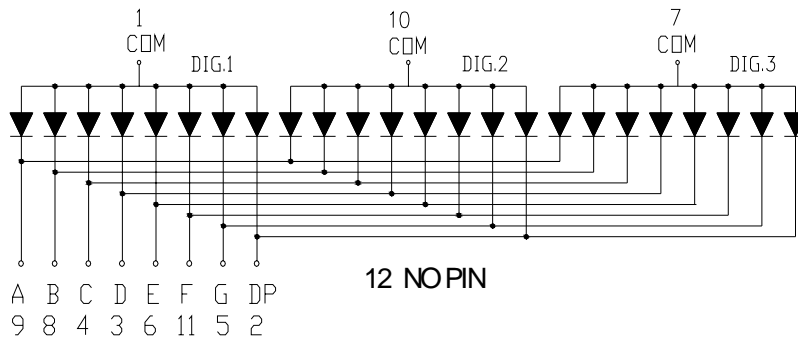

Pin Connection:

PIN NO.	CONNECTION	PIN NO.	CONNECTION
1	Common Anode Dig.1	7	Common Anode Dig.3
2	Cathode DP	8	Cathode B
3	Cathode D	9	Cathode A
4	Cathode C	10	Common Anode Dig.2
5	Cathode G	11	Cathode F
6	Cathode E	12	NO PIN

World Components Network Service Ltd

■ ABSOLUTE MAXIMUM RATINGS AT TA=25°C

Parameter	Symbol	Condition	Color	Rating	Units
Power Dissipation Per Segment	P_d	—	Yellow	65	mW
Forward Current Per Segment	I_F	—	Yellow	25	mA
Peak Forward Current Per Segment	I_{FP}	1/10 Duty 1KHz	Yellow	100	mA
Reverse Voltage Per Segment	V_R	—	Yellow	5	V
Operating Temperature Range	T_{opr}	—	—	-40~+105	°C
Storage Temperature Range	T_{stg}	—	—	-40~+105	°C

■ Electrical/Optical Characteristics Rating(Ta=25°C)

Item	Symbol	Test conditions	Location	Rating			Units
				Min.	Typ.	Max.	
Forward Voltage	V_F	$I_F=20mA$	Per Chip	1.80	2.00	2.60	V
Reverse Current	I_R	$V_R=5V$	Per Chip	—	—	100	μA
Luminous Intensity	I_V	$I_F=10mA$	Per Chip	6101	9500	15250	ucd
Wave Length	λ_P	$I_F=20mA$	Per Chip	—	595	—	nm
	λ_D			586	589	592	
Spectral Line Half Width	$\Delta \lambda$	$I_F=20mA$	Per Chip	—	—	20	nm
Luminous Intensity Matching Ratio (Segment To Segment)	I_{v-m}	$I_F=10mA$				1.2:1	

■ Luminous Intensity Sorting: (Luminous intensity tolerance :+/-10%)

Rank	Symbol	Condition	Min	Max	Unit
N	N	$I_F=10mA$	6101	7200	ucd
O	O	$I_F=10mA$	7201	8500	ucd
P	P	$I_F=10mA$	8501	10500	ucd
Q	Q	$I_F=10mA$	10501	12800	ucd
R	R	$I_F=10mA$	12801	15250	ucd

Typical Optical-Electronic Characteristic Curves

光电特性曲线

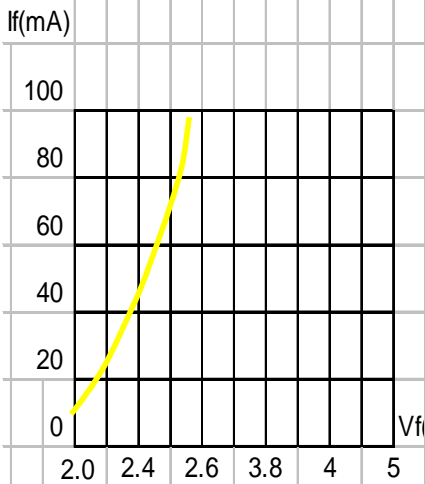

Fig.1 FORWARD CURRENT VS. FORWARD VOLTAGE.

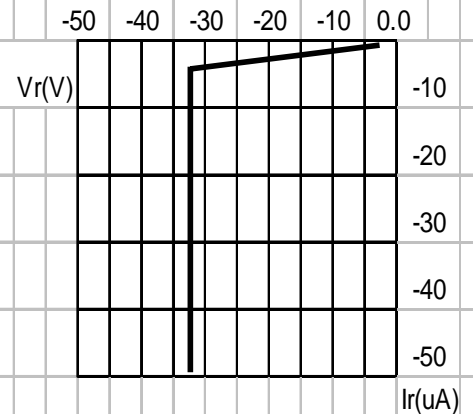
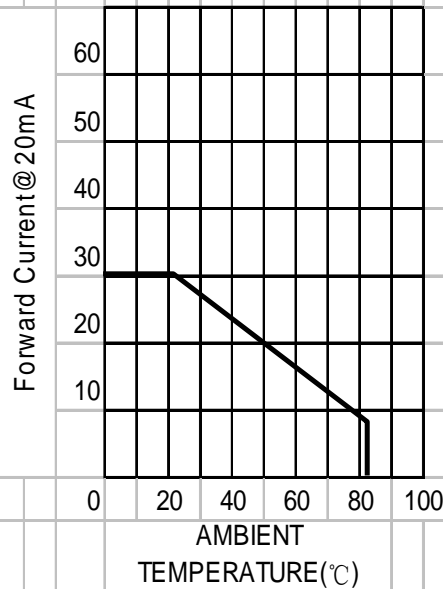
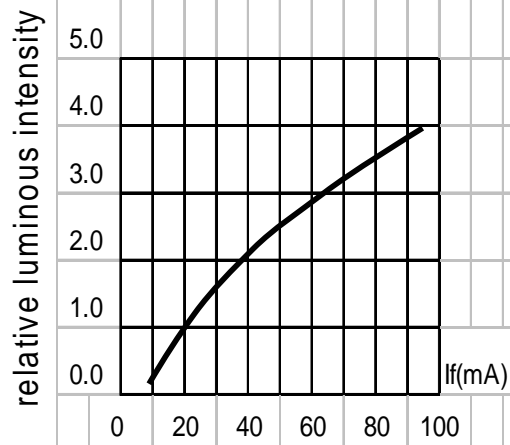
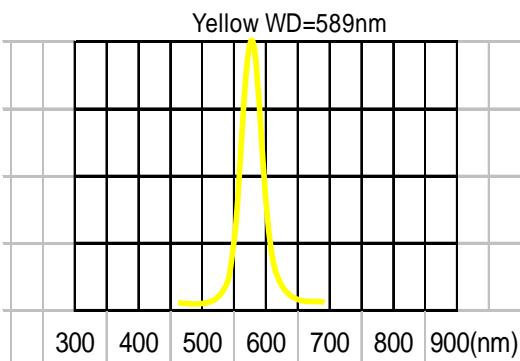
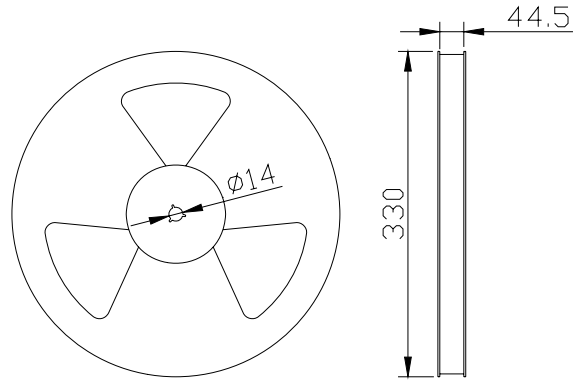

Fig.2 REVERSE CURRENT VS. REVERSE VOLTAGE.



■ Packing Reel Dimensions(mm):



■ Dimensions of Tape (Unit: mm)

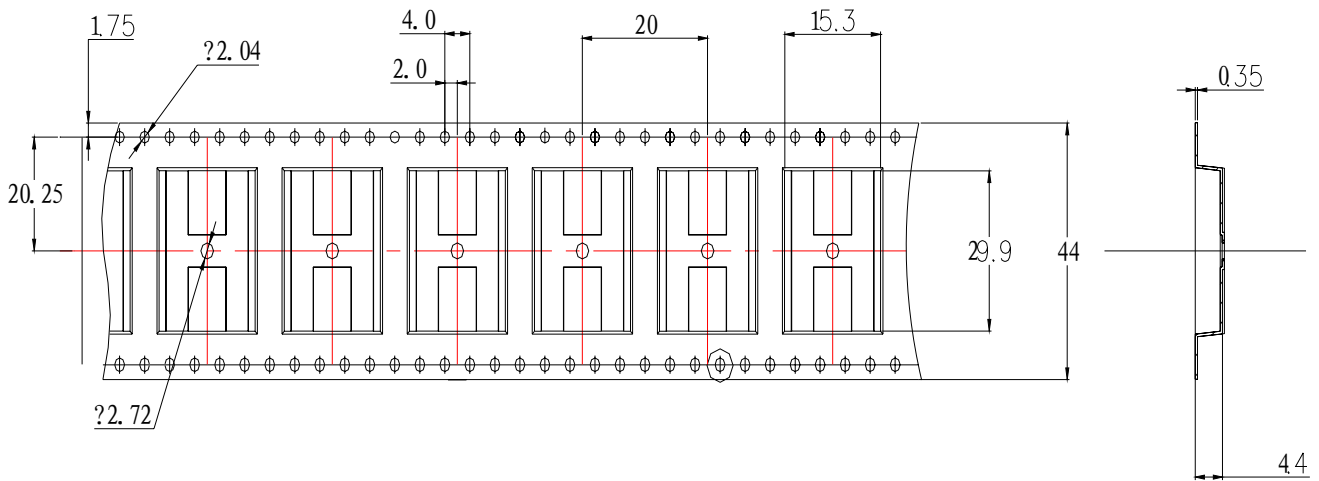

■ One Reel contained 700PCS products:

■ Recommended Soldering Pattern:

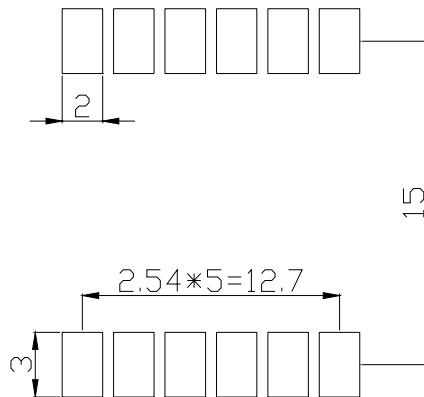

■ **Moisture Proof Packaging:**

All N/D SMD displays are shipped in moisture proof package. The displays should be stored at 30°C or less and 60% RH or less. Once the package opened, moisture absorption begins.

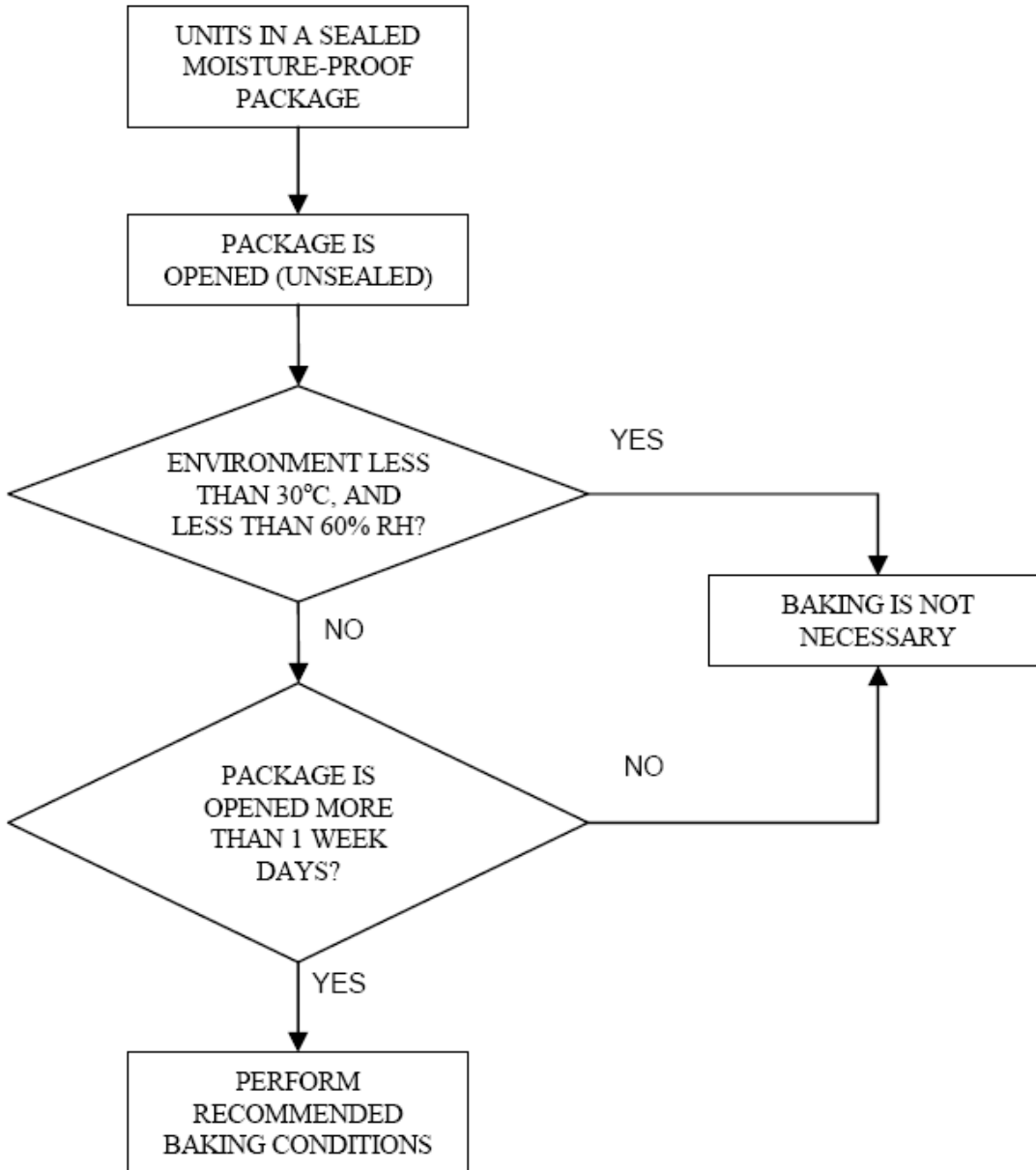

■ **Baking Conditions:**

If the parts not stored in dry conditions, they must be baked before re-flow to prevent damage to the parts.

Package	Temperature	Time
In Reel	60 °C	≥ 48hours
In Bulk	100 °C	≥ 4hours
	125 °C	≥ 2hours

■ **Baking should only be done once.**