

World Components Network Service Ltd

Customer Name:

Date:

2016-02-22

Part No:

WCN4S-1020GU-A1

**Product Group
Description:**

LED Display

Customer Part No:

Approval Date:

**Customer
Confirmation**

Approved by

Checked by

Athena
2016-2-22

Prepared By

Fei
2016-2-22

Country of Origin: China

World Components Network Service Ltd

5th Floor,Block A-2,Xuxingda Ind Zone
Shiyan Town,Bao An District , Shenzhen
Tel : (86)755-29000022
Fax : (86)755-29000023



[www . wcnopto.net](http://www.wcnopto.net)

Table of Contents

NO.	ITEM	PAGE
1	Cover	1
2	Table of Contents	2
3	Revision Record	3
4	Description	4
5	Outer Dimension and Circuit Diagram	5
6	Absolute Maximum Rating and Electrical/Optical Characteristics Rating	6
7	Typical Electrical/ Optical Characteristic Curves and Spectrometer	7
8	Packaging Data	8
9	Moisture Proof Packaging	9

World Components Network Service Ltd

REVISION RECORD

MARKER	Matter for revision	SHEET	DTAE	MAKER	APPOVED SIGN	
	Reason for revision					
A0	P# WCN4S-1020GU-A1	Whole Spec	2014-12-3	Fei	Athena	
	New Version issued					
A1	Change File's Set Type	Whole Spec	2016-02-22	Fei	Athena	
	Improved					

1. Type No./Manufacture's Name

WCN4S-1020GU-A1 / World Components Network Service Ltd.

2. Features:

- High Reliability
- Low Power Requirement
- Easy Assembly

3. Faction: Display Digit Characteristic**4. Soldering Conditions: Soldering Temp. 260 ± 5 °C, Soldering Time. 3~5 sec.**

Soldering Power <30 W.

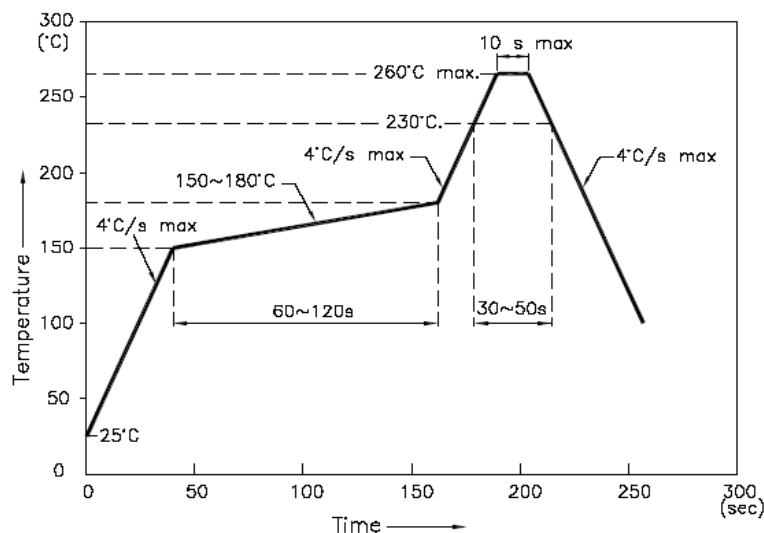
5. Re-flow Temp/Time**NOTES:**

5.1. We recommend the re-flow temperature $245^{\circ}\text{C}(\pm 5^{\circ}\text{C})$. the maximum soldering temperature should be limited to 260°C .

5.2. Don't cause stress to the epoxy resin while it is exposed to high temperature. Number of re-flow process shall be 2 times or less.

6. Description:

- Four Digit LED Display
- Digit Height: 5.08mm(0.20")
- Gray Face and Milky Segment
- Color: Yellow Green

Outer Dimension:

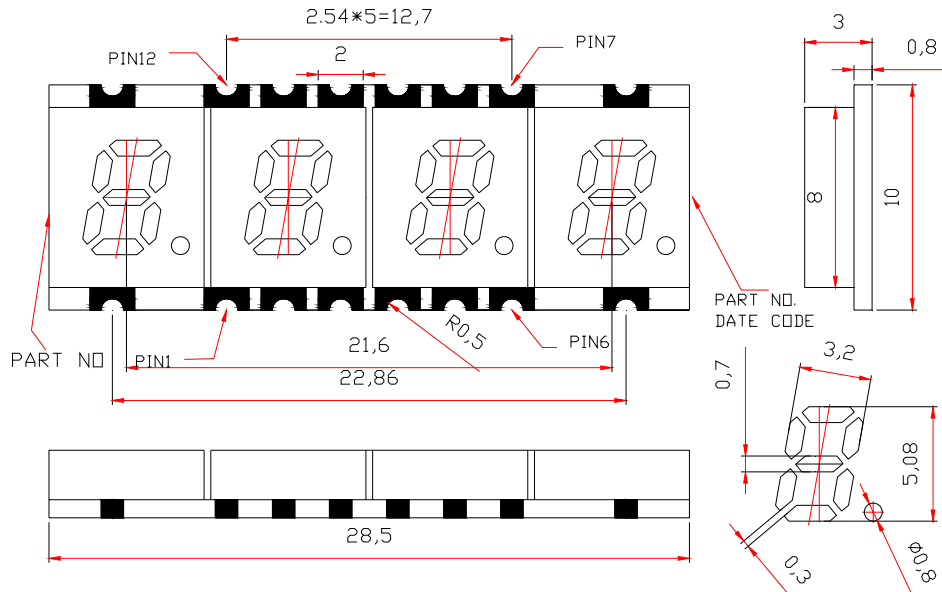

Notes: Unless otherwise stated, the tolerance is $\pm 0.25\text{mm}$.

Circuit Diagram:

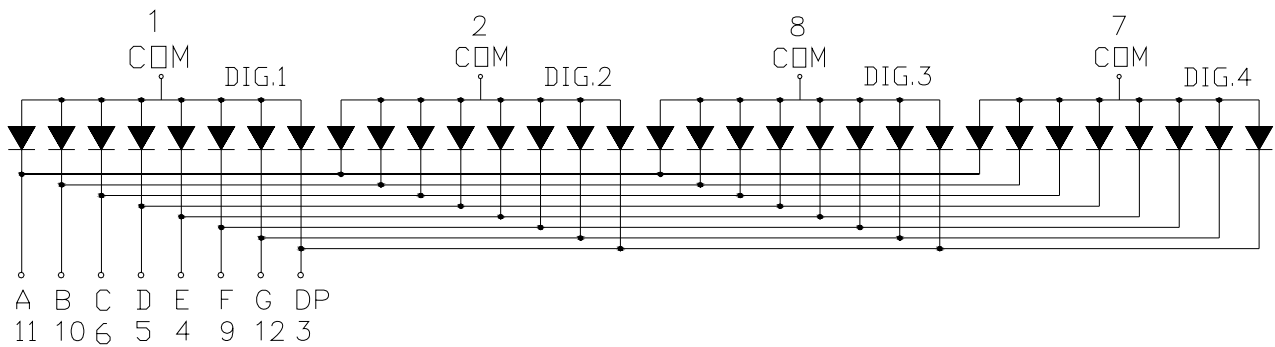

Pin Connection:

PIN NO.	CONNECTION	PIN NO.	CONNECTION
1	Common Anode dig1	7	Common Anode dig4
2	Common Anode dig2	8	Common Anode dig3
3	Cathode DP	9	Cathode F
4	Cathode E	10	Cathode B
5	Cathode D	11	Cathode A
6	Cathode C	12	Cathode G

World Components Network Service Ltd

ABSOLUTE MAXIMUM RATINGS AT TA=25°C

Parameter	Symbol	Condition	Color	Rating	Units
Power Dissipation Per Segment	P_d	—	Yellow Green	65	mW
Forward Current Per Segment	I_F	—	Yellow Green	25	mA
Peak Forward Current Per Segment	I_{FP}	1/10 Duty 1KHz	Yellow Green	100	mA
Reverse Voltage Per Segment	V_R	—	Yellow Green	5	V
Operating Temperature Range	T_{opr}	—	—	-40~+85	°C
Storage Temperature Range	T_{stg}	—	—	-40~+105	°C

Electrical/Optical Characteristics Rating(Ta=25°C)

Item	Symbol	Test conditions	Location	Rating			Units
				Min.	Typ.	Max.	
Forward Voltage	V_F	$I_F=20mA$	Per Chip	1.80	2.20	2.60	V
Reverse Current	I_R	$V_R=5V$	Per Chip	—	—	100	μA
Luminous Intensity	I_V	$I_F=10mA$	Per Chip	1351	2800	5000	ucd
Wave Length	λ_P	$I_F=20mA$	Per Chip	—	565	—	nm
	λ_D			569	571	573	
Spectral Line Half Width	$\Delta \lambda$	$I_F=20mA$	Per Segment	—	—	20	nm
Luminous Intensity Matching Ratio (Segment To Segment)	I_{v-m}	$I_F=10mA$				1.2:1	

Luminous Intensity Sorting: (Luminous intensity tolerance :+/-10%)

Rank	Symbol	Condition	Min	Max	Unit
H	H	$I_F=10mA$	1351	1750	ucd
I	I	$I_F=10mA$	1751	2350	ucd
J	J	$I_F=10mA$	2351	3050	ucd
K	K	$I_F=10mA$	3051	4000	ucd
L	L	$I_F=10mA$	4001	5000	ucd

Hue Grade: $I_F=10mA$ (Hue:+/-1nm)

Rank	Symbol	Hue Range	Units
3	3	569.1~571.0	nm
4	4	571.1~573.0	nm

■ **Typical Optical-Electronic Characteristic Curves**

Fig 1. Forward Current vs. Forward Voltage

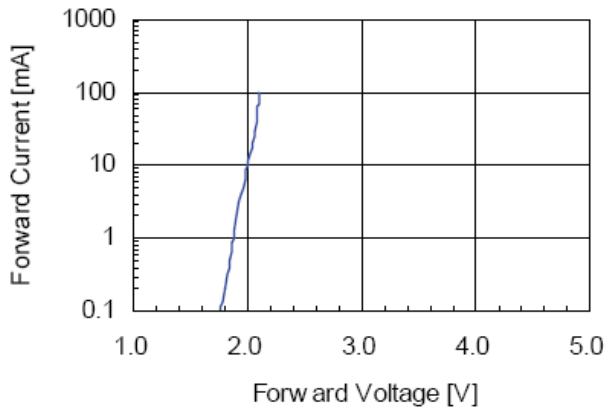

Fig 2. Relative Intensity vs. Forward Current

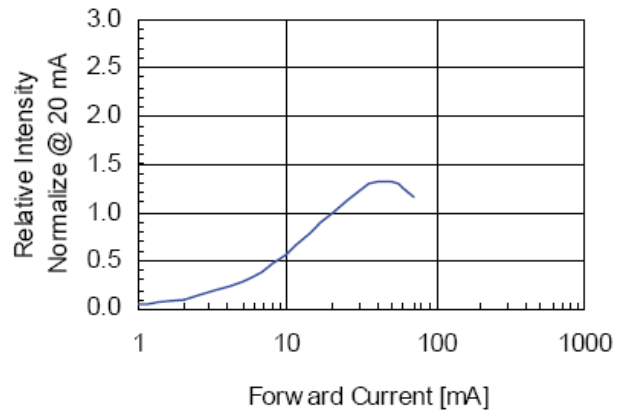

Fig 3. Forward Voltage vs. Temperature

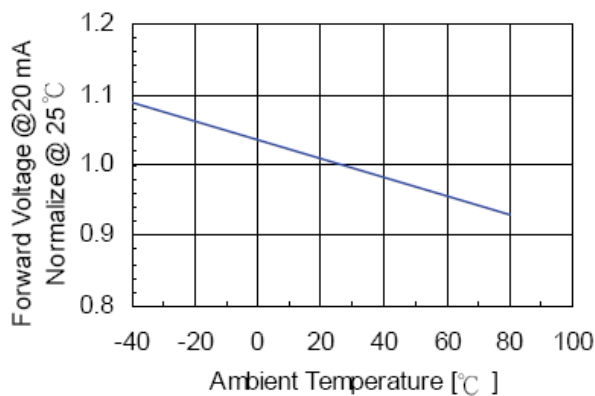

Fig 4. Relative Intensity vs. Temperature

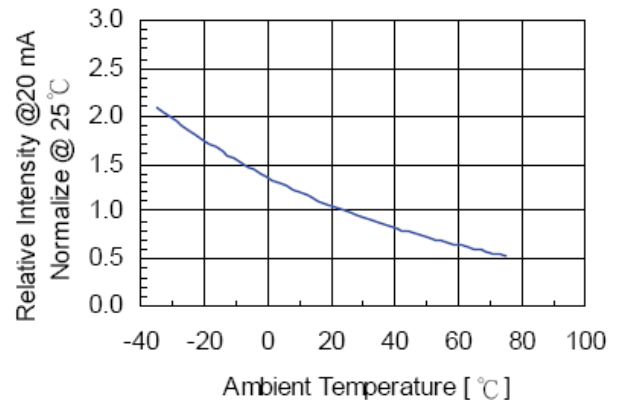
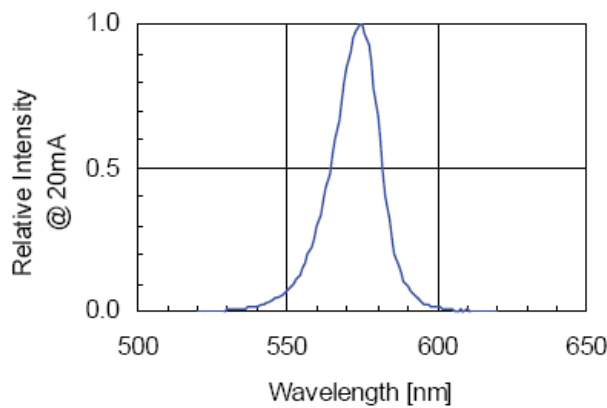
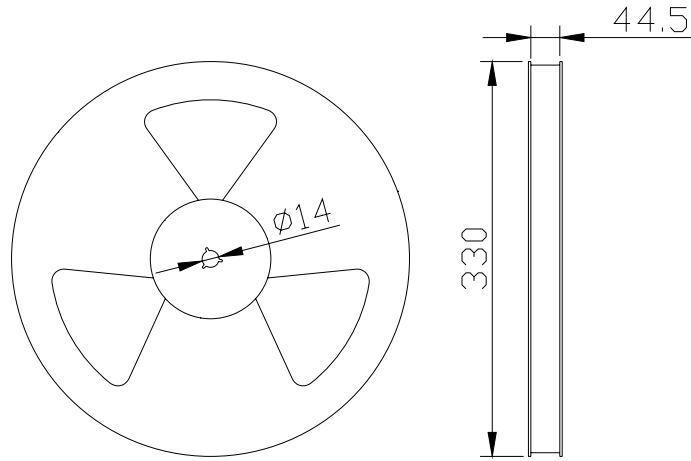

Fig 5. Relative Intensity vs. Wavelength



■ **Packing Reel Dimensions(mm):**



■ **Dimensions of Tape (Unit: mm)**

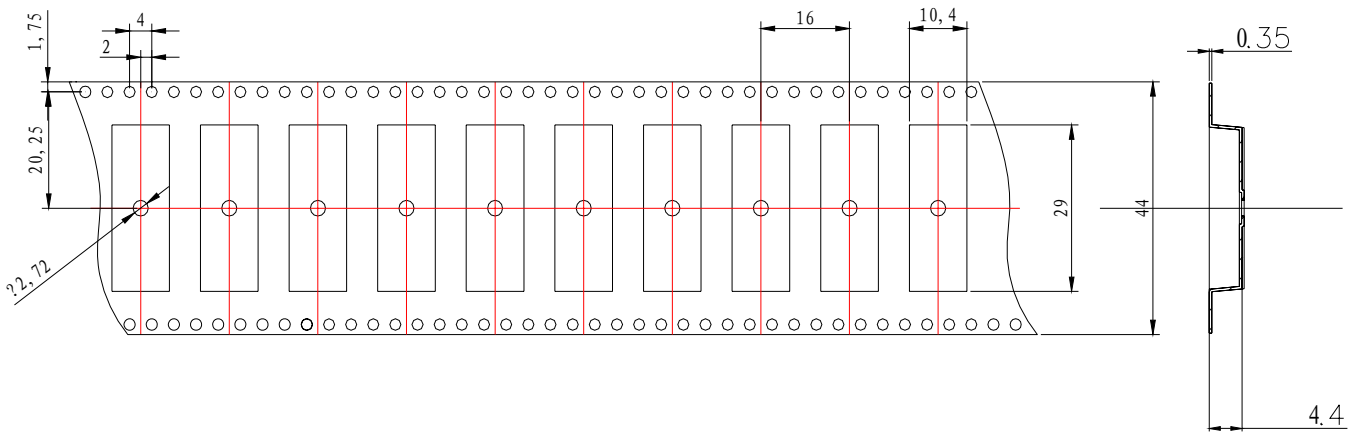

■ **One Reel contained 930 PCS products:**

■ **Recommended Soldering Pattern:**

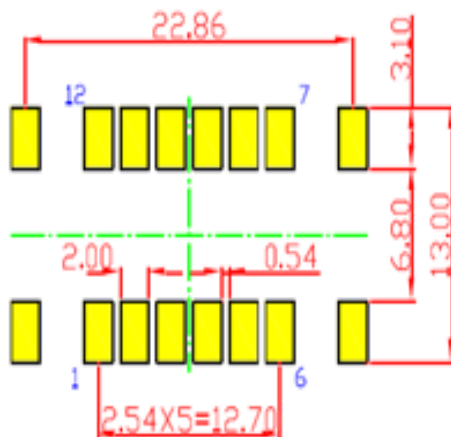

■ **Moisture Proof Packaging:**

All N/D SMD displays are shipped in moisture proof package. The displays should be stored at 30°C or less and 60% RH or less. Once the package opened, moisture absorption begins.

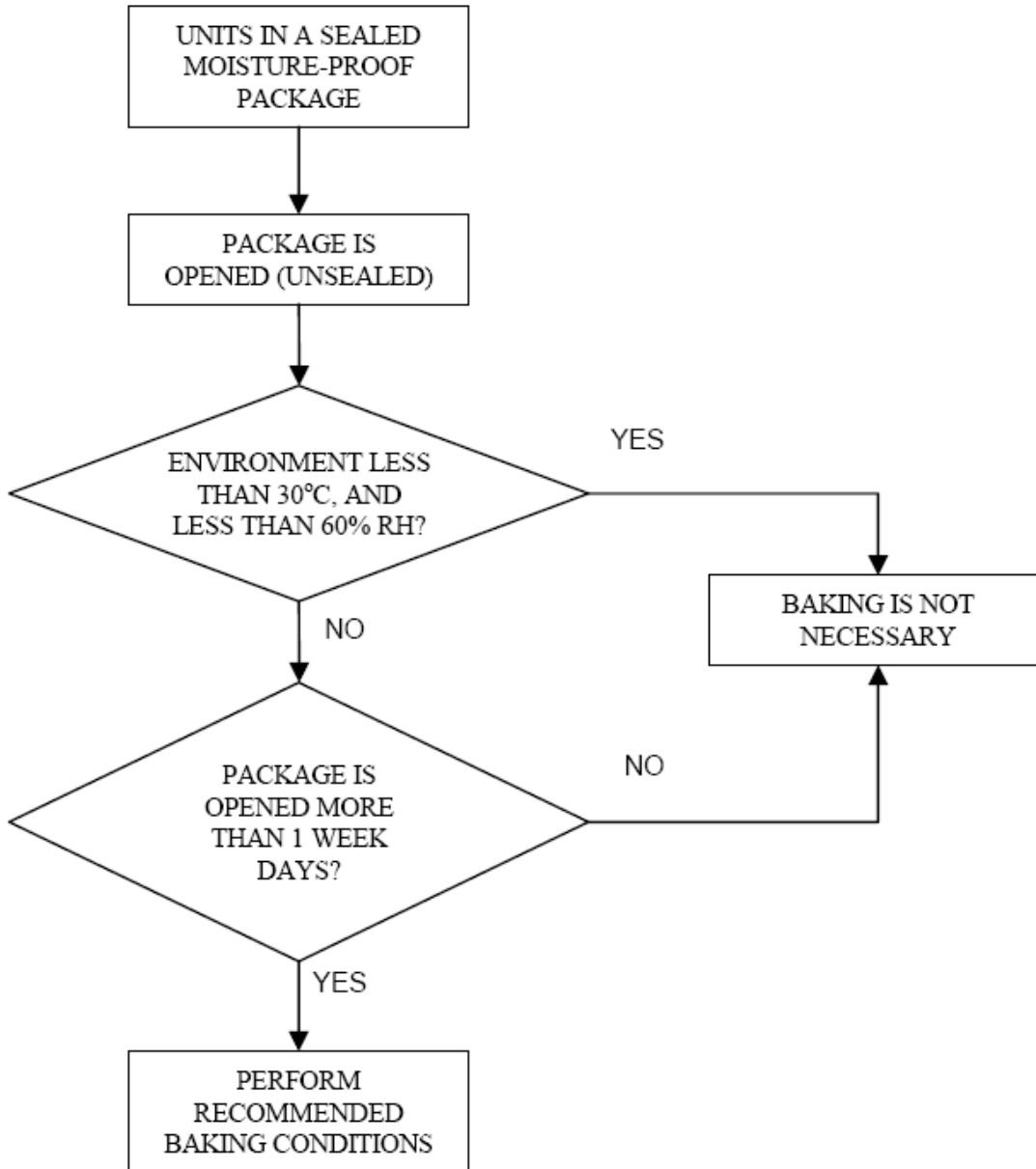

■ **Baking Conditions:**

If the parts not stored in dry conditions, they must be baked before re-flow to prevent damage to the parts.

Package	Temperature	Time
In Reel	60 °C	≥ 48hours
In Bulk	100 °C	≥ 4hours
	125 °C	≥ 2hours

■ **Baking should only be done once.**